

PLEASE READ THIS MANUAL IN ITS ENTIRETY PRIOR TO USING THIS PRODUCT!

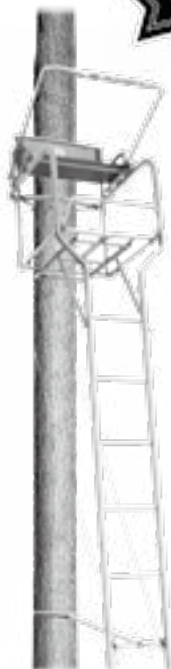

Model RTL-300 INSTRUCTION MANUAL



Do not return this product to the retailer. Call Rhino Treestands for replacement of any damaged parts, toll-free at (888) 507-2021.

Inspect ALL product components for evidence of damage or wear sustained during shipping, handling, manufacturing of the product prior to assembly or use. If for any reason you are not satisfied with product or with any product component, DO NOT use until the problem has been resolved.

MEMBER OF

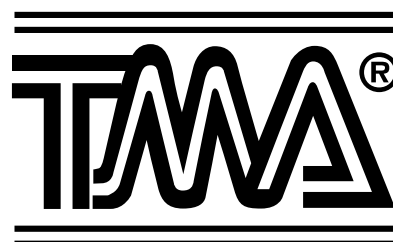

TREESTAND MANUFACTURERS ASSOCIATION

This Instruction Manual meets industry standards recognized by the Treestand Manufacturers Association - "Standard Practice for Treestand Instructions" and - "Standard Test Method for Treestand Fall Arrest Systems"



WARNING! THIS PRODUCT CARRIES A STRICT WEIGHT LIMIT. DO NOT USE THIS PRODUCT IF YOU EXCEED THIS TOTAL WEIGHT LIMIT. PLEASE NOTE THIS WEIGHT LIMIT INCLUDES THE USER AND EQUIPMENT. FAILURE TO FOLLOW THESE INSTRUCTIONS MAY RESULT IN SERIOUS INJURY OR DEATH!

Model Number RTL-300

Maximum Weight Capacity - 300 pounds (136kgs) (User and Equipment)



WARNING! You must read, understand, and follow ALL safety warnings and instructions prior to each use. Additionally, you must test and practice with product at ground-level prior to using it at heights above ground-level. Failure to follow these instructions will result in serious injury or death!



WARNING! You must wear and use the Rhino Treestands full-body fall arrest harness and linemen's belt at all times when setting up (installing), using and/or removing this Rhino Treestands product(s). Failure to follow these instructions may result in serious injury or death!



WARNING! Prior to each hunt, make certain you have a signaling device (e.g., mobile phone, cell phone, radio, whistle, signal flare, Personal Locator Device [PLD], etc.) in your possession and on your person in an operable condition. This device must be within easy access shall you experience the need to contact emergency assistance. Failure to follow these instructions may result in serious injury or death!

THANK YOU FOR YOUR PURCHASE OF THIS QUALITY RHINO TREESTANDS PRODUCT! TO ENSURE YOUR PERSONAL SAFETY, PLEASE TAKE A MOMENT TO CAREFULLY READ THIS PRODUCT INSTRUCTION MANUAL IN ITS ENTIRETY BEFORE ATTEMPTING TO SET-UP, INSTALL AND/OR OTHERWISE USE THIS RHINO TREESTANDS PRODUCT. FAILURE TO DO SO COULD RESULT IN SERIOUS PERSONAL INJURY OR DEATH! THIS RHINO TREESTANDS PRODUCT HAS BEEN DESIGNED, ENGINEERED AND MANUFACTURED TO PROVIDE YOU WITH YEARS OF TROUBLE FREE SERVICE.

Shall you have any questions about the installation and/or use of this product, or any other Rhino Treestands product(s) do not hesitate to call one of our customer service representatives toll-free at (888) 507-2021 or visit us online at rhinotreestands.com. Our service representatives will answer any questions you may have about any of the complete line of Rhino Treestands products.

PLEASE READ THIS MANUAL IN ITS ENTIRETY PRIOR TO USING THIS PRODUCT!



ATTENTION!!



WHEN YOU SEE A "WARNING!" BE SURE TO HEED THE MESSAGE! THE INFORMATION CONTAINED IN THESE MESSAGES CAN SAVE YOUR LIFE!!



WARNING! FALLS FROM A TREESTAND CAN OCCUR ANYTIME AFTER LEAVING THE GROUND. THESE FALLS RESULT IN EITHER SERIOUS INJURY OR DEATH! FOR YOUR PERSONAL SAFETY, PLEASE TAKE A MOMENT TO CAREFULLY READ THIS PRODUCT INSTRUCTION MANUAL IN ITS ENTIRETY BEFORE ATTEMPTING TO ASSEMBLE, SET-UP, INSTALL AND/OR OTHERWISE USE THIS RHINO TREESTANDS PRODUCT. AT LEAST ANNUALLY, REVIEW THE CONTENTS OF THIS INSTRUCTION MANUAL AND WATCH THE SAFE TREESTAND HUNTING DVD. ADDITIONALLY, KEEP THESE INSTRUCTIONS FOR THE ENTIRE DURATION YOU OWN THIS PRODUCT(S). FAILURE TO FOLLOW THESE INSTRUCTIONS MAY RESULT IN SERIOUS INJURY OR DEATH!



WARNING! THE SAFE USE AND OPERATION OF THIS PRODUCT(S) IS THE SOLE RESPONSIBILITY OF THE USER. A SAFE TREESTAND HUNTING VIDEO HAS BEEN PROVIDED WITH THIS PRODUCT. YOU MUST WATCH THIS DVD IN ITS ENTIRETY. IT IS ALSO THE SOLE RESPONSIBILITY OF THE OWNER TO PROVIDE ANY PERSON(S) WHO BORROW OR PURCHASE THIS PRODUCT WITH THESE INSTRUCTIONS AND THE SAFE TREESTAND HUNTING VIDEO. FAILURE TO FOLLOW THESE INSTRUCTIONS MAY RESULT IN SERIOUS INJURY OR DEATH! ADDITIONALLY, FAILURE TO FOLLOW THESE INSTRUCTIONS MAY SUBJECT YOU TO PERSONAL LIABILITY PENALTIES AS DETERMINED BY THE U.S. JUDICIAL SYSTEM.



WARNING! Failure to read and strictly comply with the instructions contained in this Instruction Manual may result in serious injury or death! PLEASE NOTE THAT "WARNING!" statements have been placed throughout this Instruction Manual. These statements point-out important safety information and instructions, which, if not followed, could endanger the personal safety and/or property of the operator. It is imperative that the operator of this product, or any other Rhino Treestands product(s) read and understand all the instructions and warnings contained in this Instruction Manual prior to attempting to use this product(s), or any other Rhino Treestands product(s). Failure to comply with these instructions and/or warnings may result in serious injury or death! When you see a "WARNING!" statement- BE SURE TO HEED THE MESSAGE!



WARNING! Thoroughly inspect this or any other Rhino Treestands product(s) prior to each use for signs of wear, rot, corrosion, cracks, deterioration and/or any other type of defect. DO NOT expose this product to extended exposure to direct sunlight, excessive heat or freezing temperatures. Do not use this or any other Rhino Treestands product(s) if they show evidence of wear, rot, corrosion, cracks, deterioration and/or any other type of defect. Failure to follow these instructions may result in serious injury or death!



WARNING! Do not remove, modify and/or omit any portion or otherwise mechanically modify this Rhino Treestands product(s) or its assemblies in any manner. Modification, additions, misuse and/or part substitution shall immediately void your factory warranty and may result serious injury or death! If you suspect a part(s) is missing and/or defective, immediately contact Rhino Treestands toll free at (888) 507-2021 for replacement of missing or defective parts. Never modify your stand in any way by making repairs, or altering, adding or attaching anything to it except if explicitly authorized in writing by Rhino Treestands. ALWAYS USE GENUINE FACTORY AUTHORIZED RHINO TREESTANDS REPLACEMENT PARTS. USE OF ANY REPLACEMENT PARTS OTHER THAN GENUINE RHINO TREESTANDS PARTS VOIDS YOUR WARRANTY AND RELIEVES RHINO TREESTANDS OF ANY RESULTANT LIABILITIES AND MAY RESULT IN SERIOUS INJURY OR DEATH!



WARNING! This Rhino Treestands product(s) is designed for adult use only. No one under the age of 16 shall attempt to use this or any other Rhino Treestands product(s) without direct adult supervision. Replace all hardware/cables/nuts/bolts/clips on your tree stand every two (2) years or sooner if inspection finds it necessary. Use only Rhino Treestands replacement straps and parts. Use of any other straps or parts, which are not genuine Rhino Treestands straps and parts, will be viewed as a modification to the product. Any modification will void the warranties and relieve Rhino Treestands Inc. from all liabilities. Failure to follow these instructions may result in serious injury or death!



WARNING! Prior to attempting to use this or any other Rhino Treestands product(s), you must take a moment and become familiar with its assembly, setup and installation. You must practice installing, setting-up and using this product(s) at ground level prior to attempting to use it at heights above ground-level. Once you have become thoroughly knowledgeable and comfortable with this Rhino Treestands product(s) set-up, installation and use at ground-level, you are now ready to use it at heights about ground-level. Failure to follow these instructions may result in serious injury and death!



WARNING! ALWAYS inspect/check ALL expiration dates/tags on all straps and the full-body fall arrest harness prior to each use. You must replace ALL straps (ratchet, cinch, button, stabilizing straps/ropes, etc.) and suspension seats EVERY year. Never use any strap(s) or full-body fall arrest harness that has expired or is showing any damage or wear. Replace all hardware/cables/nuts/bolts/clips on your tree stand every (2) years or sooner if inspection finds it necessary. Use only Rhino Treestands replacement straps and parts. Any other straps or parts will be viewed as a modification to the product. Any modification will void the warranties and relieve Rhino Treestands Inc. from all liabilities. Failure to follow these instructions may result in serious injury and death!



WARNING! When hunting from a treestand, falls can occur any time after leaving the ground causing injury or death. Always wear your Rhino Treestands full-body fall arrest system comprising a full-body fall arrest harness at all times after leaving the ground. You must stay connected at all times after leaving the ground. Single safety belts and chest harnesses are no longer allowed and shall never be used as they put the user at serious risk of injury or death. If you are not wearing your full-body fall arrest harness properly attached to the tree that is protecting you from a fall, do not leave the ground. Failure to follow these instructions may result in serious injury or death!



WARNING! Never rely on a tree branch for support while climbing. Failure to follow these instructions may result in serious injury or death!



WARNING! You must always inform someone of your hunting location, where the treestand will be located and the expected duration of the hunt. Failure to follow these instructions may result in serious injury or death!



WARNING! Inspect all safety devices each time before each use. DO NOT use these devices if it (they) shows signs of wear, damage, deterioration, or vandalism. Factors such as tree growth, vandals, weather and animals may affect the performance of an unattended tree stand. Do not store these devices outdoors when not in use. Failure to follow these instructions may result in serious injury or death!



PLEASE READ THIS MANUAL IN ITS ENTIRETY PRIOR TO USING THIS PRODUCT!

PLEASE READ THIS MANUAL IN ITS ENTIRETY PRIOR TO USING THIS PRODUCT!

ATTENTION!!

WHEN YOU SEE A "WARNING!" BE SURE TO HEED THE MESSAGE! THE INFORMATION CONTAINED IN THESE MESSAGES CAN SAVE YOUR LIFE!!



WARNING! Practice the use your full-body fall arrest harness at ground level in the presence of a responsible adult to experience the feeling of hanging suspended before using it in a hunting environment. Failure to follow these instructions may result in serious injury or death!



WARNING! The length of the full-body fall arrest lanyard must be minimized at all times. It shall be adjusted so it is above the head with no slack (snug) in the sitting position and you shall have the minimum amount of slack possible when climbing. Failure to follow these instructions may result in serious injury or death!



WARNING! Failure to follow harness instructions could result in not being able to return to the stand and being suspended in a harness after a fall. If your hunting location is unknown by anyone and communication efforts are unsuccessful, you must have a personal plan for self-recovery/escape shall you experience a fall. Prolonged suspension in a harness can be fatal. It is important to exercise the legs by pushing against the tree or doing other forms of continuous leg exercises to avoid blood pooling while being suspended. Varying degrees of physical fitness may require different plans for self-recovery/escape to minimize the effects of prolonged suspension. Have a personal plan and practice it in the presence of a responsible adult before leaving the ground. No one escape/rescue plan will work for every hunter, on every tree, in every circumstance. Only you can determine the best self-recovery/escape plan for your hunting situation and you must have a self-recovery/escape plan for your individual situation before leaving the ground. There is time to make a correct decision on what action to take if a fall occurs while wearing a full-body fall arrest harness. It is important to remember, "DO NOT PANIC." You must only hunt from the ground when self-recovery/escape ability is absent. Failure to follow these instructions may result in serious injury or death!



WARNING! A suspension relief device must be on your person and readily accessible while using a harness. These devices allow the user to relieve the load on the lower extremities if suspended in a harness and help maintain circulation in the legs, mitigate suspension trauma (blood pooling) or allow descent to the ground. Be sure to follow the manufacturers' directions on the safe use of any suspension relief device. Several optional products/systems are available that offer self-recovery or self extraction from a fall when suspended in a harness. Some systems automatically descend the user while others allow user control. One of these products/systems can be considered for use as an additional safety precaution against prolonged suspension and suspension trauma. Be sure to follow the manufacturers' directions on the safe use of these products/systems. Failure to follow these instructions may result in serious injury or death!



WARNING! If you have a limiting physical and/or health condition that precludes and/or renders you incapable of self-recovery and/or a suitable escape plan is not available, DO NOT hunt from heights above ground level. Failure to follow these instructions may result in serious injury or death!



WARNING! NEVER allow the harness lanyard to get under your chin or around your neck. This poses a choking hazard that can lead to serious injury or death. Failure to follow these instructions may result in serious injury or death!



WARNING! Never attempt to climb up or climb down with a weapon and/or gear in your possession. ALWAYS unload your weapon and pull it up to hunting height using a tether or pull up rope. ALWAYS lower your unloaded weapon down to the ground prior (when raising or lowering firearms, the chamber must be open and the barrel pointing toward the ground) to attempting to climb down. Use this same method when raising or lowering all other gear. Failure to follow these instructions may result in serious injury or death!



WARNING! DO NOT attempt to use this and/or any other Rhino Treestands product(s) when ice, snow and/or freezing rain has deposited or formed on any portion of the tree you intend to climb. Failure to follow these instructions may result in serious injury or death!



WARNING! ALWAYS maintain three-point contact when climbing up/down a tree when using climbing aids (e.g., ladders, climbing sticks, stacking steps, etc.). Proper three-point contact means having either two (2) feet with one (1) hand or one (1) foot with two (2) hands on the step portion of the climbing aids at all times when climbing up or down. Failure to follow these instructions may result in serious injury or death!



WARNING! NEVER adjust ANY straps, cables, and/or adjustable support bars while standing on or leaning against any treestand. DO NOT use any treestand if there is any damage, wear, or excessive corrosion on any part of the treestand or the full-body fall arrest harness. Failure to follow these instructions may result in serious injury or death!



WARNING! DO NOT modify, fix/repair, alter, bend, cut, weld, or heat this product in any way. Failure to follow these instructions will void warranty and may result in serious injury or death!



WARNING! DO NOT lean out from a treestand for any reason. Never use your full-body fall arrest harness to help you lean out of your treestand to make a difficult shot. Failure to follow these instructions may result in serious injury or death!



WARNING! DO NOT use this or any other Rhino Treestands product(s) if you have a history of heart problems, back problems, impaired vision, joints that lock-up, spinal fusions, equilibrium problems, high blood pressure, are not well-rested and/or any other physical impairment that may limit your ability to use and/or operate this product(s) in the safe manner outlined in this Instruction Manual. Additionally, do not use this or any other Rhino Treestands product(s) if you are currently taking any medication (including prescription) and/or using and/or consuming any substance, including alcohol, that may limit your ability to use this Rhino Treestands product(s) as outlined and described in the Instruction Manual. Never use a treestand when feeling ill, nauseous or dizzy. Do not use ANY Rhino Treestands product(s) without consent from your medical doctor for safe and proper use of the treestand and fall arrest system. Failure to follow these instructions may result in serious injury or death!



WARNING! DO NOT attempt to use this or any other Rhino Treestands product(s) when thunderstorms are threatening and/or present within five (5) miles. Do not attempt to use this or any other Rhino Treestands product(s) when any other adverse weather condition presents itself. These include weather conditions which have the potential for producing winds, lightning, rain, snow, sleet and/or any other atmospheric condition which may limit the user's ability to operate this Rhino Treestands product(s) in a safe manner as described in this Instruction Manual. Shall inclement weather conditions arise during your use of this Rhino Treestands product(s), return to the ground immediately. Failure to follow these instructions may result in serious injury and death!



WARNING! Never leave a treestand in a tree for more than two (2) weeks (14 days) as weather and/or animals could cause damage. Tree growth can also stress and damage straps, chains and buckles. Failure to follow these instructions may result in serious injury or death!









WARNING! DO NOT use this product, or attempt to use a treestand, on a dead, leaning, diseased, loose barked tree (bark that flakes or falls off), irregular shaped trees, or utility poles. DO NOT use this product on any tree that does not allow for a level standing platform. Failure to follow these instructions may result in serious injury or death!



WARNING! Never jump or bounce on a treestand to seat it to the tree. Failure to follow these instructions may result in serious injury or death!



SPECIAL CONSIDERATIONS FOR LADDER TREESTAND USAGE

-  WARNING! You must use at least three (3) adults to install and/or take down this ladder treestand. Failure to follow these instructions may result in serious injury or death!
-  WARNING! You must install and attach the criss-cross straps (i.e., 16' stabilizing ropes) and other stabilization devices as described in this Instruction Manual prior to attempting to climb this treestand. Failure to follow these instructions may result in serious injury or death!
-  WARNING! When installing this ladder treestand you must bounce on the first rung to set the ladder into the ground prior to attempting to climb any higher. Failure to follow these instructions may result in serious injury or death!
-  WARNING! You must check every ladder section connection every time you use the stand before you leave the ground. If you find that the ladder sections are separating, DO NOT USE the treestand. Failure to follow these instructions may result in serious injury or death!
-  WARNING! You must check the ground under the treestand to make sure it is firm and level. Sloping ground or uneven surfaces (e.g., one foot on a rock) can cause your ladder to tilt or shift off the tree as you climb. Failure to follow these instructions may result in serious injury or death!
-  WARNING! You must maintain three (3) points-of-contact when climbing a ladder treestand (i.e., two feet-one hand, two hands-one foot). Failure to follow these instructions may result in serious injury or death!
-  WARNING! You must always lean forward as you climb and attach your full-body fall arrest harness to the tree before securing the platform to the tree and stepping onto the standing platform. Failure to follow these instructions may result in serious injury or death!

RHINO TREESTANDS FULL-BODY FALL ARREST HARNESS

We are very serious about your personal safety. A Rhino Treestands full-body fall arrest harness has been included with this product for your use. The Rhino Treestands full-body fall arrest harness has been designed to keep you from experiencing a fall. Remember, the most important part of your hunt is returning home to your family safe and sound.

READ THE RHINO TREESTANDS FULL-BODY FALL ARREST HARNESS MANUAL CAREFULLY AND FOLLOW ALL THE INSTRUCTIONS! YOUR NEW FULL-BODY FALL ARREST HARNESS IS DESIGNED FOR A MAXIMUM CAPACITY OF 300 POUNDS (136kgs). ADDITIONALLY, YOUR NEW FULL-BODY FALL ARREST HARNESS MUST BE REPLACED AFTER TWO (2) YEARS OF SERVICE! REPLACE YOUR HARNESS IMMEDIATELY SHALL YOU EXPERIENCE A FALL WHILE WEARING IT.

-  WARNING! Use only the Rhino Treestands full-body fall arrest harness that meets ASTM standards and is provided with this product. NOTE: You must store your full-body fall arrest harness out of direct sunlight and out of any other harsh environmental condition(s) that may adversely affect its performance. Failure to follow these instructions may result in serious injury or death!

RHINO TREESTANDS RTL-300 COMPONENTS

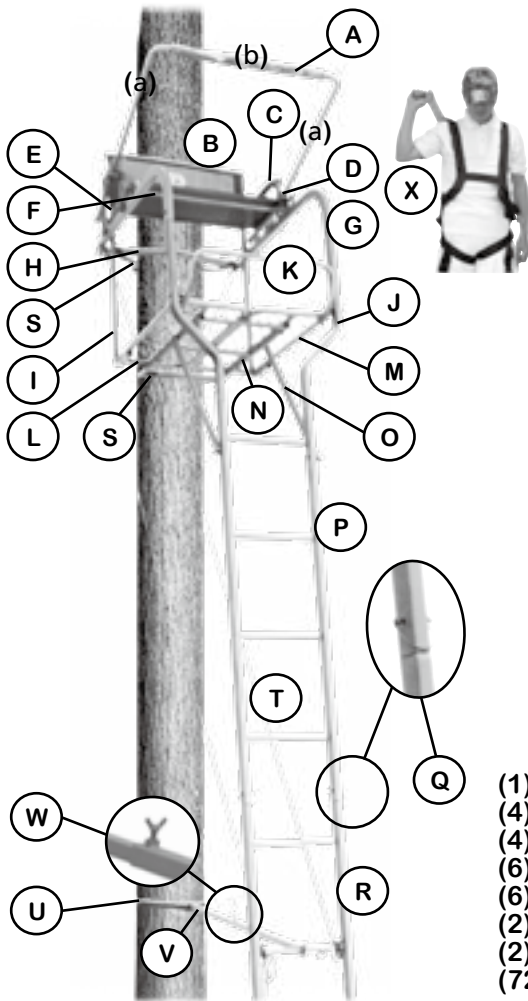

- | | | |
|----|--------------------------------------|-----------------|
| A. | (1) Shooting Rail Assembly (a/b/a) | Part #SR-370 |
| B. | (1) Mesh Seat With 2 Plastic Tubes | Part #LSC-300 |
| C. | (2) Arm Rests | Part #AR-316 |
| D. | (2) Adjustable Shooting rail sleeves | Part #AS-200 |
| E. | (2) Seat Tubes | Part #ST-714 |
| F. | (1) Front Seat Support Tube | Part #FST-316 |
| G. | (2) Seat Support Tubes | Part #SST-316 |
| H. | (1) V-bar | Part #VB-376 |
| I. | (2) Platform Support Brace | Part #PSB-399 |
| J. | (2) Z Connection Tubes | Part #ZT-316 |
| K. | (1) Foot Rest | Part #FR-370 |
| L. | (1) Left Foot Platform | Part #LFP-316 |
| M. | (1) Right Foot Platform | Part #RFP-316 |
| N. | (1) Sub-frame | Part #SF-316 |
| O. | (2) Cross bars (27-3/4") | Part #CT-705 |
| P. | (1) Top Ladder Section | Part #TLS-316 |
| Q. | (4) Quick Pins | Part #8010 |
| R. | (2) Ladder Sections | Part #L-316 |
| S. | (2) Looped Ratchet Strap | Part #LR-200 |
| T. | (4) 16' Stabilizing Ropes | Part #TR-250 |
| U. | (1) 8' Stabilizing Rope | Part #TR-200 |
| V. | (1) Adjustable Support Bar Assembly | Part #ASA-505 |
| W. | (1) Adjustment Wingbolt | Part #8520 |
| X. | (1) Full-Body Fall Arrest Harness | Part #RTH-2000S |
| | (1) Shooting Rail Pad | Part #P376 |
| | (10) Thick Plastic Washer | Part #4510 |
| | (2) 6mm Long Quick Bolt | Part #7028 |
| | (1) 8mm x 1-5/8" Bolt | Part #1513 |
| | (4) 8mm x 2-1/8" Bolt | Part #1516 |
| | (4) 8mm x 3-1/8" Bolt | Part #1521 |
| | (6) 6mm x 1-3/8" Bolt | Part #1012 |
| | (6) 6mm x 2-1/8" Bolt | Part #1016 |
| | (2) 6mm x 4" Bolt | Part #1025 |
| | (2) Arm Rest Pads | Part #F451 |
| | (72) Nylon Washer | Part #4010 |
| | (8) 8mm x 2" Bolt | Part #1515 |
| | (4) 6mm x 2" Bolt | Part #1015 |
| | (16) 8mm Locknut | Part #2510 |
| | (18) 6mm Locknut | Part #2010 |
| | (4) Tube Caps | Part #4514 |
| | (1) Wingnut | Part #6010 |
| | (2) Silence tube | Part #1650 |

FIGURE 1: RHINO TREESTANDS RTL-300 COMPONENTS

PLEASE READ THIS MANUAL IN ITS ENTIRETY PRIOR TO USING THIS PRODUCT!

PLEASE READ THIS MANUAL IN ITS ENTIRETY PRIOR TO USING THIS PRODUCT!

RHINO TREESTANDS RTL-300 ASSEMBLY

Note: Do NOT tighten any nuts/bolts until product is fully assembled. You will need two (2) 13mm wrenches and two (2) 10mm wrenches to tighten the assembly (not provided).

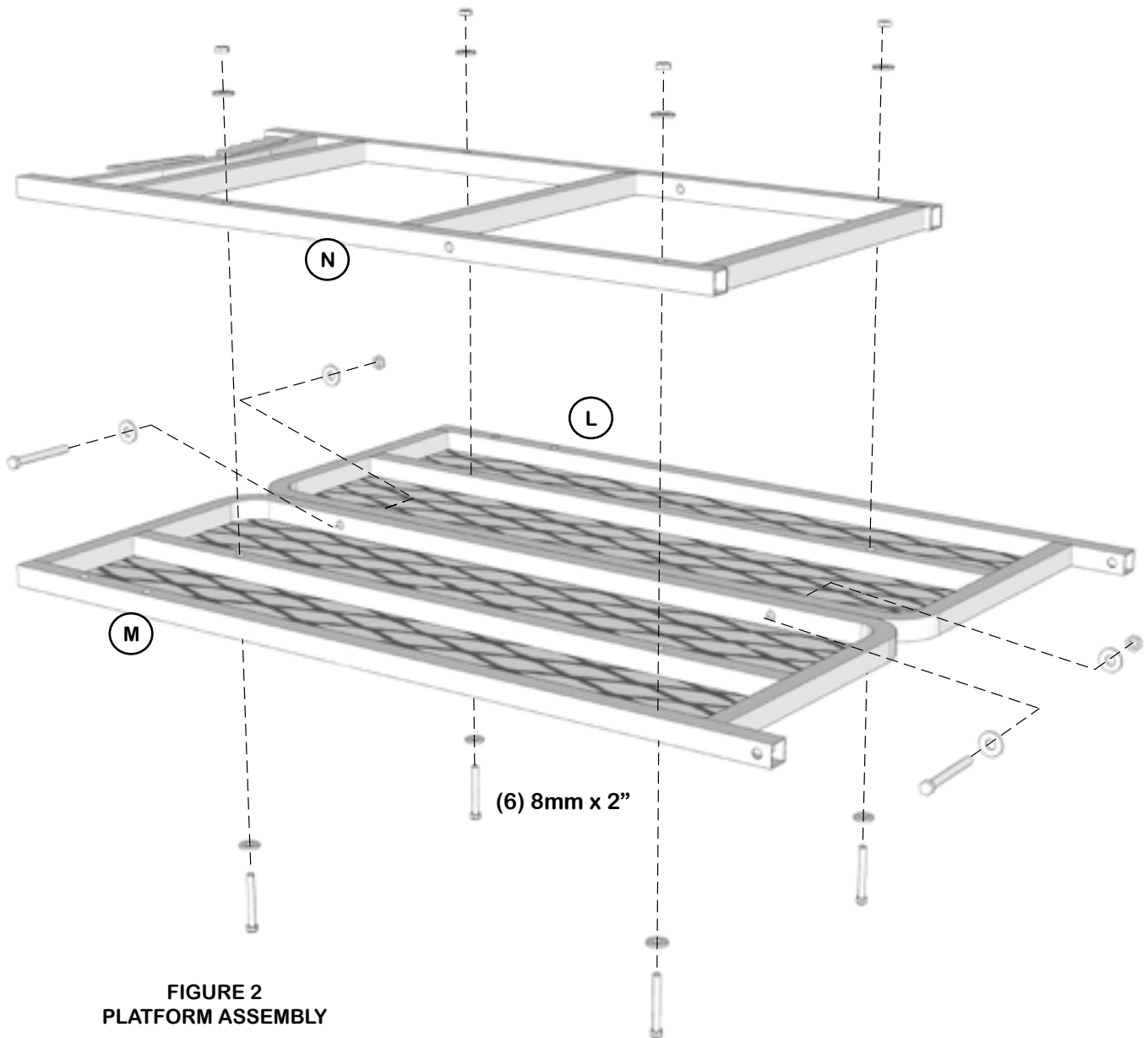

**FIGURE 2
PLATFORM ASSEMBLY**

STEP 1: Locate the left/right foot platform (L&M) . Bolt them together using two (2) 8mm x 2" bolts and locknuts. Locate the sub-frame (N). Bolt it to the assembled platforms using four (4) 8mm x 2" bolts and locknuts.

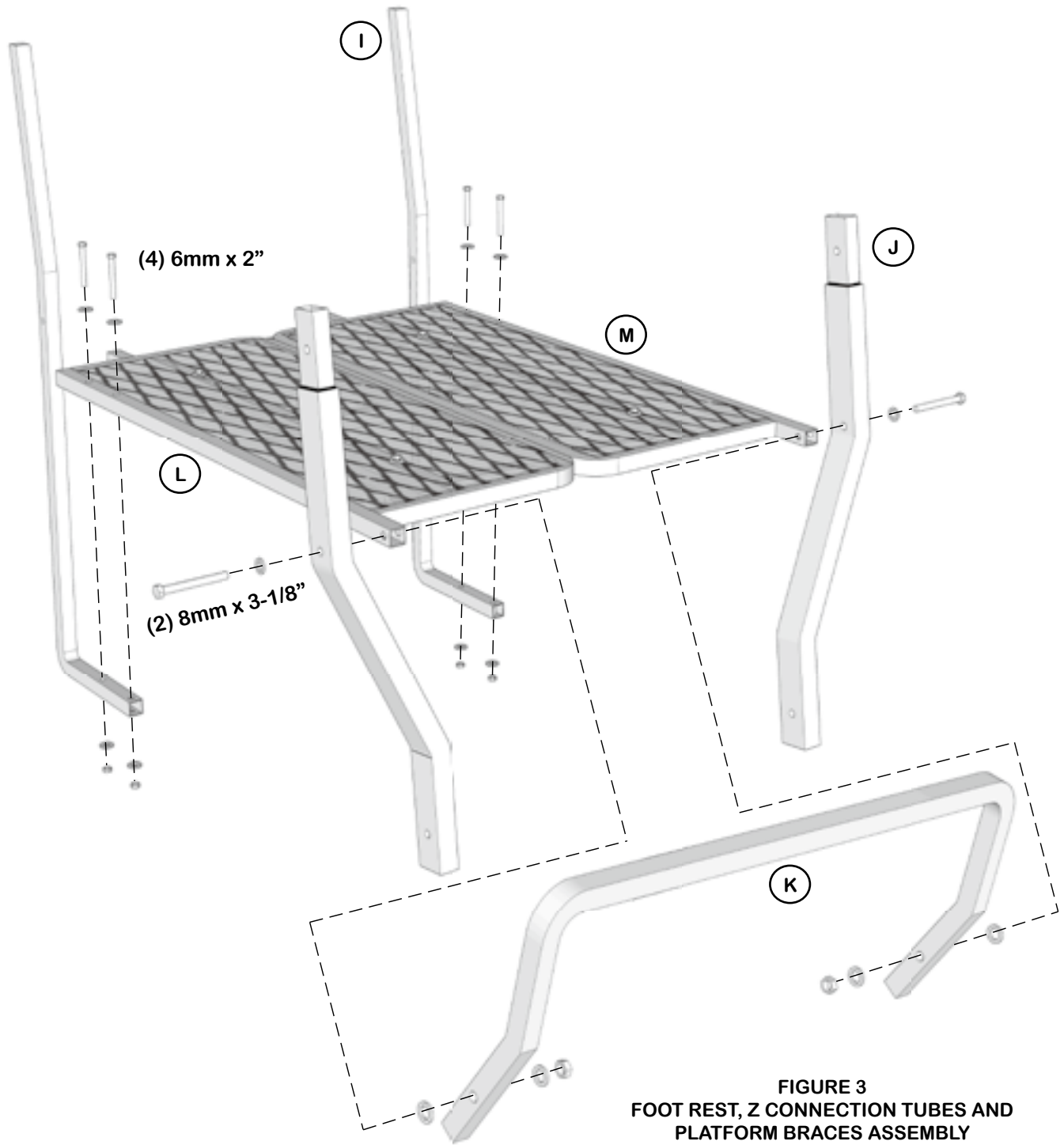

FIGURE 3
FOOT REST, Z CONNECTION TUBES AND
PLATFORM BRACES ASSEMBLY

STEP 2: Locate the foot rest (K) and Z connection tubes (J) (refer to Figure 1). Install them with assembled platforms using four (4) 8mm x 3-1/8" bolts and locknuts. Locate the platform braces (I), Install them to the back side of the assembled platform using four (4) 6mm x 2" bolts and locknuts.

PLEASE READ THIS MANUAL IN ITS ENTIRETY PRIOR TO USING THIS PRODUCT!

PLEASE READ THIS MANUAL IN ITS ENTIRETY PRIOR TO USING THIS PRODUCT!

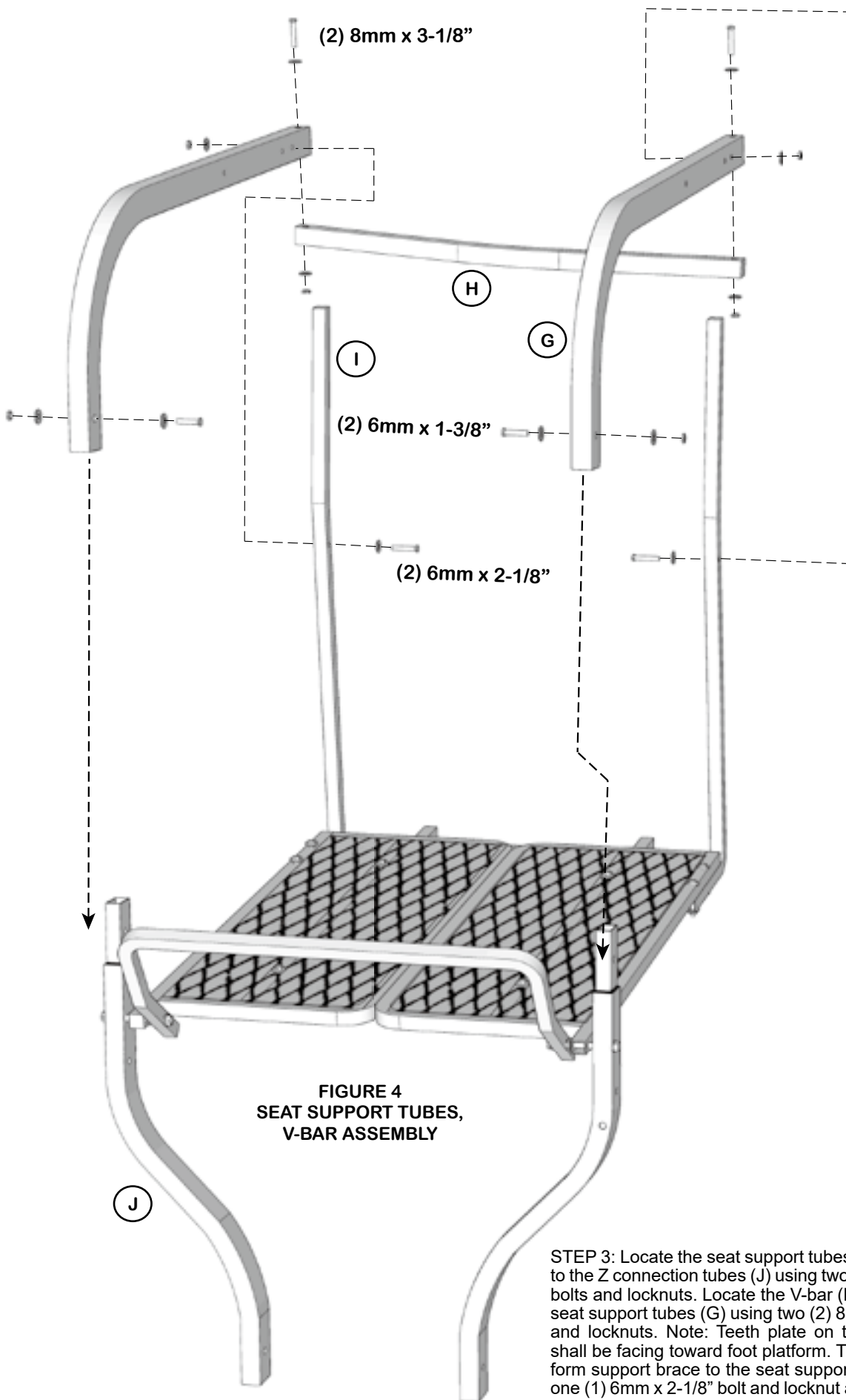

FIGURE 4
SEAT SUPPORT TUBES,
V-BAR ASSEMBLY

STEP 3: Locate the seat support tubes (G). Install them to the Z connection tubes (J) using two (2) 6mm x 1-3/8" bolts and locknuts. Locate the V-bar (H). Install it to the seat support tubes (G) using two (2) 8mm x 3-1/8" bolts and locknuts. Note: Teeth plate on the welded V-bar shall be facing toward foot platform. Then Bolt the platform support brace to the seat support tubes (G) using one (1) 6mm x 2-1/8" bolt and locknut and repeat on the 2nd platform support brace.

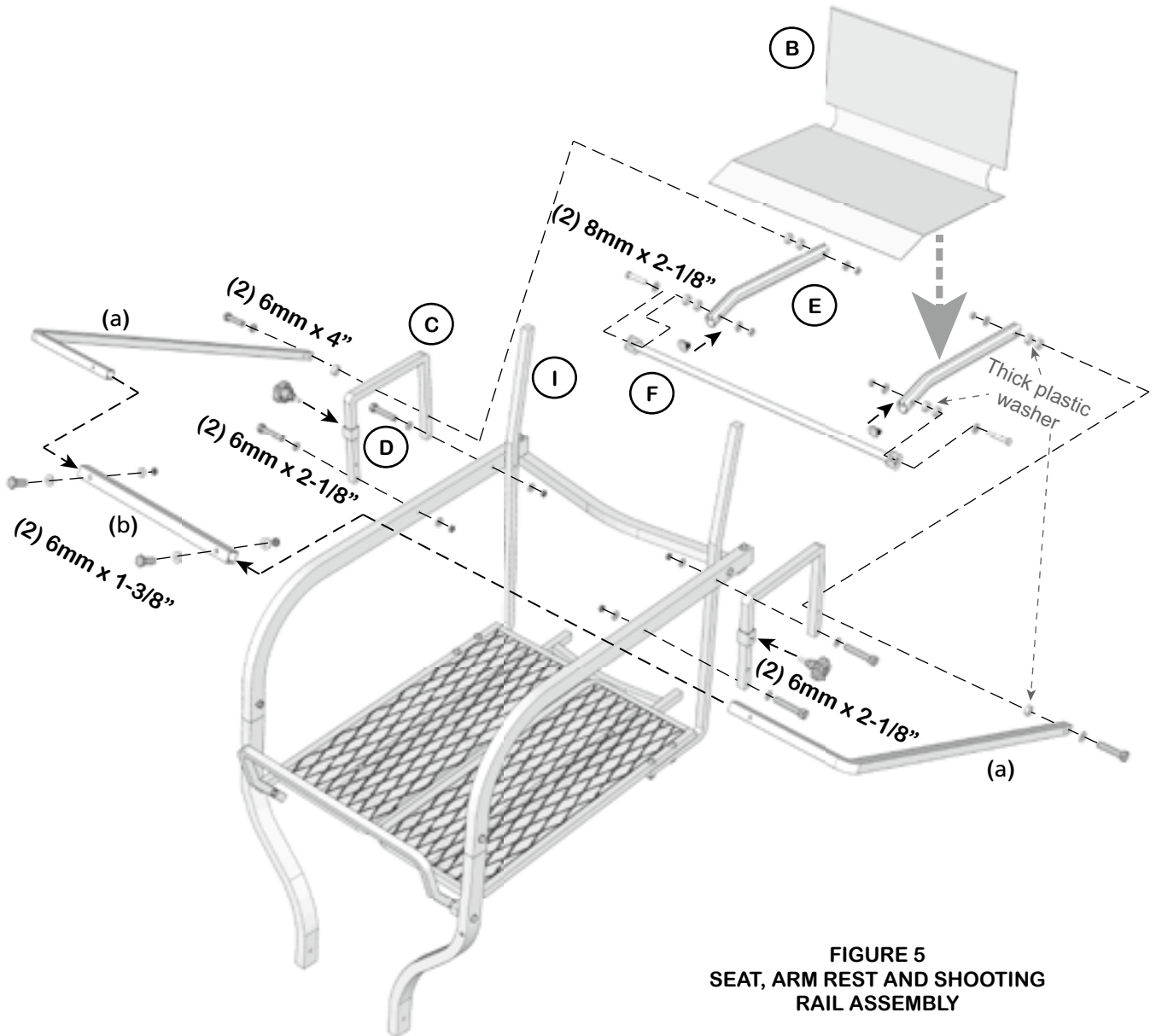

FIGURE 5
SEAT, ARM REST AND SHOOTING
RAIL ASSEMBLY

STEP 4: Locate the arm rests (C) and adjustable shooting rail sleeves (D), insert the adjustable shooting rail sleeve to the front of the arm rest which has the 2nd hole in the arm rest lower than other side. Bolt the arm rests (C) to the outside of seat support tubes (G), using (2) 6mm x 2-1/8" bolts and locknuts, repeat on other side. Locate the seat tubes (E), front seat support tube (F), mesh seat with (2) plastic tubes (B), Install mesh seat with (2) plastic tubes (B) to seat tubes (E). Using one (1) 8mm x 2-1/8" bolt and locknut on each side, bolt the seat tubes (E) to the front seat support tube (F) with two (2) thick plastic washers on each side between the seat tubes (E) and front seat support tube (F). Insert the pockets on the back mesh seat to the platform support braces (I). Locate the shooting rail assembly (A). Insert the shooting rail sections (a) to the middle section (b) on each side, bolt together using two (2) 6mm x 1-3/8" bolts and locknuts. Locate the assembled mesh seat containing parts (B,E&F) and bolted shooting rail assembly (A). Install them to the arm rests using two (2) 6mm x 4" bolts, six (6) thick plastic washers and two (2) 6mm locknuts. (Bolt Stack: shooting rail → thick plastic washer → arm rest → two (2) thick plastic washer → seat tube).

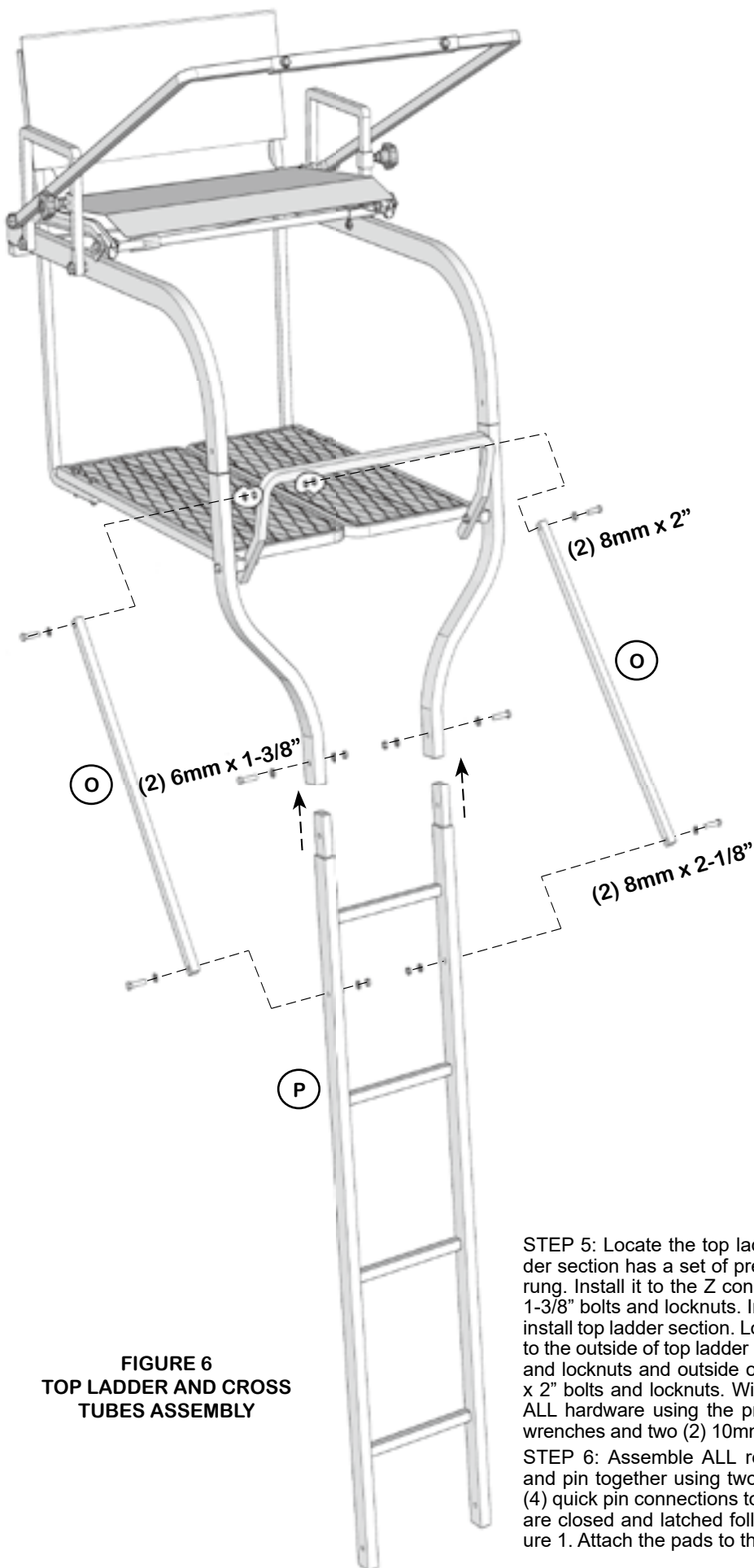

FIGURE 6
TOP LADDER AND CROSS
TUBES ASSEMBLY

STEP 5: Locate the top ladder section (P), Note: the top ladder section has a set of pre-drilled holes below the top ladder rung. Install it to the Z connection tubes using two (2) 6mm x 1-3/8" bolts and locknuts. Important: All bolts must be loose to install top ladder section. Locate the cross bars (O), install them to the outside of top ladder (P) using two (2) 8mm x 2-1/8" bolts and locknuts and outside of the sub-frame using two (2) 8mm x 2" bolts and locknuts. With all installed, go back and tighten ALL hardware using the previously mentioned two (2) 13mm wrenches and two (2) 10mm wrenches (not included).

STEP 6: Assemble ALL remaining ladder sections together and pin together using two (2) quick pins (Q). There are four (4) quick pin connections total. Make certain that all quick pins are closed and latched following installation as shown in Figure 1. Attach the pads to the arm rest and shooting rail.

INSTALLING YOUR RHINO TREESTANDS RTL-300

PLEASE READ THIS MANUAL IN ITS ENTIRETY PRIOR TO USING THIS PRODUCT!

PLEASE READ THIS MANUAL IN ITS ENTIRETY PRIOR TO USING THIS PRODUCT!



WARNING! You must wear and use the RHINO TREESTAND full-body fall arrest harness and linemen's belt at all times when setting up (installing), using and/or removing this Rhino Treestands product(s). Failure to follow these instructions may result in serious injury or death!



WARNING! You must follow these installation instructions very carefully. Failure to follow these instructions may result in serious injury or death!



WARNING! You must check the ground under the treestand to make sure it is firm and level. Sloping ground or uneven surfaces (e.g., one foot on a rock) can cause your ladder to tilt or shift off the tree as you climb. Failure to follow these instructions may result in serious injury or death!



WARNING! Never attempt to climb any ladder stand without insuring the Adjustable Ladder Support Bar Assembly and the Criss-Cross ropes are present and are properly secured to the tree. Failure to follow these instructions may cause serious injury or death!



WARNING! Prior to attempting to use this, or any other Rhino Treestands product(s), you must take a moment and become familiar with it's setup and installation at ground-level. You must practice installing, setting-up and using this product(s) at ground-level prior to attempting to use it at heights above ground-level. Once you have become thoroughly knowledgeable and comfortable with this Rhino Treestands product(s) setup, installation and use at ground-level, you're now ready to use it at heights above ground-level. Failure to follow these instructions may result in serious injury or death!



WARNING! STOP NOW!!!! Make sure that you are wearing your Rhino Treestands full-body fall arrest harness. Failure to follow these instructions may result in serious injury or death!



WARNING! Your Rhino ladder was designed, engineered and constructed in a manner that makes it a rugged piece of hunting equipment that will give you years of trouble-free service. This rugged-construction makes your Rhino ladder physically heavy. As such, you shall never attempt to install this ladder by yourself.



YOU MUST HAVE A MINIMUM OF THREE (3) ADULTS FOR THE SAFE ERECTION OF YOUR TREESTAND.



WARNING! Prior to climbing, make sure that all the ladder sections are firmly connected and the ladder assembly is solidly secured to the tree. Failure to follow these instructions will result in serious injury or death!



WARNING! You must have at least three (3) adults to install and/or remove this ladder treestand. Failure to follow these instructions may result in serious injury or death!



WARNING! Prior to attempting to climb a ladder stand for the first time, make certain the feet of the bottom rung ladder section are firmly planted on solid, level ground. If they are not firmly planted on level ground, DO NOT climb the ladder. With the help of three (3) adults, lower the stand and find a suitable location to safely install the ladder stand. Failure to follow these instructions may result in serious injury or death!



WARNING! When climbing to secure the ratchet strap, it is important to lean forward when climbing to keep the stand centered and secure to the tree trunk. DO NOT lean backwards when climbing! Failure to follow these instructions will result in serious injury or death!



FIGURE 7
ADJUSTABLE SUPPORT
BAR ASSEMBLY INSTALLED
(LADDER SHOWN
UPRIGHT FOR CLARITY)

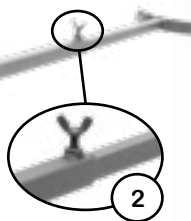

FIGURE 8
RATCHET STRAPS &
BUTTON STABILIZING
STRAPS INSTALLED



STEP 1: Select a straight, healthy tree with a minimum diameter of 12-inches (31cm) at the v-bar (H) installation height.

STEP 2: Insure all ladder sections are assembled properly and quick pins (Q) are installed and closed as shown in Figure 1 for each ladder section. Check ALL bolts and locknuts on the entire stand to insure all are securely tightened. Review ALL product instructions/warnings for proper assembly and final inspection of all the parts to insure all items are free from damage or wear. Do not use if there are any damaged or missing parts.

WARNING! As you approach the top of the ladder, attach your full-body fall arrest harness tether to the tree trunk as soon as possible. After your tether has been attached to the tree, attach the looped ratchet strap to secure the top of the stand to the tree. Do not sit or stand on the standing platform until the looped ratchet strap has been securely fastened. Failure to follow these instructions will result in serious injury or death!

WARNING! When climbing, always maintain three (3) points-of-contact as you ascend (i.e., climb up) and while descending (i.e., climb down). Failure to maintain three (3) points-of-contact puts the user at serious risk of bodily injury. Failure to follow these instructions will result in serious injury or death!

WARNING! DO NOT use this, or any other Rhino product(s) to climb utility poles, telephone poles, structural columns or any other man-made structures. Never use this or any other Rhino product(s) around power generation (e.g., transformers, generators, substations, etc.) and/or power transmission equipment. Failure to follow these instructions will result in serious injury or death!

STEP 3: Lay the assembled ladder stand face down on the ground with the feet of the lower ladder section 3 or 4 feet (91cm and 122cm) away from the base of the tree. Locate the adjustable support bar assembly (V) (refer to Figure 1). Install the adjustable support bar assembly (V) to the fifth ladder rung from the ground level (as shown in Figure 7). Bolt the bar to the welded tabs using one (1) 8mm x 1-5/8" bolt and one (1) wingnut (as shown in Figure 7). Tighten securely. Make certain the v-bar portion of the adjustable support bar assembly (V) is extended away from the ladder sections. Note: The adjustable support bar assembly (V) adjusts for length by loosening the wingbolt (as shown in Figure 7) and sliding the assembly in or out to accommodate length requirements. Once adjustments have been made, you must retighten the wingbolt prior to use.

STEP 4: Locate the two (2) looped ratchet straps (S) (refer to Figure 1). Install the looped end(s) of the ratchet strap assembly to each side of the v-bar as shown in Figure 8. For installation and threading instructions refer to Figure 9.

STEP 5: Locate two (2) 16' stabilizing ropes (T), Install the two (2) 16' stabilizing ropes (T) on the v-bar, tying one (1) 16' stabilizer rope onto each of the two (2) sides of the v-bar as shown in Figure 1. Note: Attach by tying a secure knot. Allow the looped ratchet strap (S) and the two (2) 16' stabilizing ropes (T) to hang freely downward

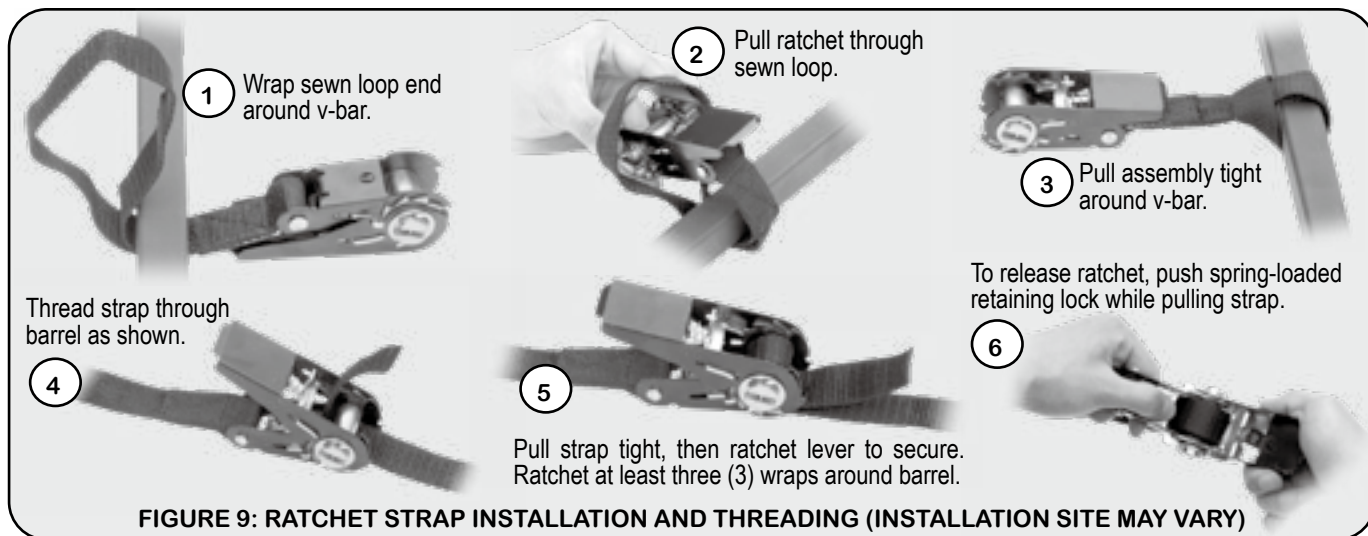

STEP 6: With three (3) or more adults, carefully raise the assembled ladder stand up until the ladder stand rests into the center of the v-bar (H) and foot platform assembly(L,M,N) are level. Note: DO NOT stand in the direct path or underneath any treestand at any time. If need be, drive a stake into the ground at the first ladder rung to prevent the ladder stand from sliding toward the tree while raising and lowering of the ladder stand.

Note: With two (2) adults raising the treestand into place, have one (1) adult pulling on the two (2) 16' stabilizing ropes (T) from behind the tree. By doing so, this helps guide the treestand safely into place.

STEP 7: To level the v-bar (H) and foot platform assembly (L,M,N), move the ladder stand in or out until the platforms are level. Once level, stand on the bottom ladder rung until it is firmly seated on the ground.

Note: When raising/lowering your treestand, DO NOT flex/stress the ladder sections by arching or bending them as too much stress or flex in the ladder sections will cause permanent damage in the ladder sections.

STEP 8: With the treestand level, and the v-bar (H) flush against the tree trunk, adjust the adjustable support bar assemblies (V) length until the "V" end is firmly against the tree trunk. Tighten the wingbolt securely.

Note: The ladder sections shall be slightly arched away from the tree.

STEP 9: Locate the one (1) 8' stabilizing rope (U) (refer to Figure 1). Secure the adjustable support bar assembly (V) "V" end to the tree using the 8' stabilizing rope (U) as shown in Figure 10.



PLEASE READ THIS MANUAL IN ITS ENTIRETY PRIOR TO USING THIS PRODUCT!

PLEASE READ THIS MANUAL IN ITS ENTIRETY PRIOR TO USING THIS PRODUCT!

Note: NEVER adjust the adjustable support bar assembly (V) once your stand is in position and your platforms are level.

STEP 10: Locate the two (2) 16' stabilizing straps (T) hanging down from the v-bar. Pull down on the straps from behind the tree and criss-cross the straps behind the tree to form an "X" with the straps. Keeping tension on the straps, walk around to the front of the tree and connect each strap to the push button that is secured to the 5th ladder rung from the bottom as shown in Figure 7. These straps will hold the top section to the tree until the platform section is secured to the tree with the looped ratchet strap (S). NEVER REMOVE the straps from the tree nor attempt to climb the ladder unless the 8' stabilizing rope (U) two (2) 16' button straps (T) and adjustable support bar assembly (V) are firmly attached to the tree.

Note: Review, understand, and follow all looped ratchet strap (S) instructions for proper threading (refer to Figure 9) prior to leaving the ground to secure the looped ratchet strap (S). Check to insure all ladder sections are secured with quick pins (Q) and quick pins in place and closed. Make certain the ground is firm and level under the bottom ladder section, and all the 8'/16' stabilizing ropes/straps (U/T) and the adjustable support bar assembly (V) are secured firmly against the tree.

STEP 11: Next, being extremely careful, slowly climb up while leaning forward with three (3) points-of-contact as you climb. Upon arrival to top ladder rung, attach your full-body fall arrest tether to the tree prior to securing the looped ratchet strap (S). Next, wrap the looped ratchet strap (S) around the tree trunk and thread as shown in Figure 9. Secure the looped ratchet strap (S) firmly against the tree by ratcheting the assembly. Tie off loose ends. Always check ALL straps before each use for damage or wear. NEVER stand and/or kneel on the foot or seat platforms while securing or removing the looped ratchet strap (S) to or from the tree.



WARNING! You MUST install your Rhino Treestand level. Any installation other than level, will result in a dangerous condition for the user. If you find your treestand canted, unlevel or in any condition other than level, you must remove it and find an alternative installation site that affords level installation. Failure to follow these instructions will result in serious injury or death!



WARNING! DO NOT use this, or any other Rhino Treestands product(s) to climb utility poles, telephone poles, structural columns or any other man-made structures. Never use this, or any other Rhino Treestands product(s) around power generation (e.g., transformers, generators, substations, etc.) and/or power transmission equipment. Failure to follow these instructions will result in serious injury or death!

REMOVING YOUR RTL-300 TREESTAND



WARNING! STOP NOW!!!! Make sure that you are wearing your Rhino Treestands full-body fall arrest harness! Failure to follow these instructions may result in serious injury or death!



WARNING! DO NOT remove the adjustable support bar or 8'/16' stabilizing ropes/straps until you are ready to lean this product away from the tree while you are safely on the ground. Failure to follow these instructions will result in serious injury or death!



WARNING! DO NOT remove the adjustable support bar assembly or 8'/16' stabilizing ropes/straps unless you are doing so from the ground. DO NOT remove these with any person standing on any portion or the ladder and/or ladderstand assembly. Failure to follow these instructions may result in serious injury or death!



WARNING! Prior to attempting to use this or any other Rhino Treestands product(s) you must take a moment and become familiar with it's setup and installation at ground level. You must practice installing, setting-up and using this product(s) at ground-level prior to attempting to use it at heights above ground-level. Once you have become thoroughly knowledgeable and comfortable with this Rhino Treestands product(s) setup, installation and use at ground-level, you're now ready to use it at heights above ground-level. Failure to follow these instructions may result in serious injury or death!

STEP 1: Inspect to insure that all stabilizing straps/ropes are securely attached to the tree. Make certain the adjustable support bar assembly (V) is properly attached to the tree, ladder sections are pinned together, and that the ground beneath the ladder sections are firm and level, next slowly climb up the ladder stand maintaining three (3) points-of-contact while leaning slightly forward as you climb. Once you reach the platform, attach your full-body fall arrest harness tether to the tree securely. Review all full-body fall arrest harness instructions and warnings prior to each use and before leaving the ground. While attached to tree with your full-body fall arrest harness, keeping your weight centered with the platform, carefully disengage the looped ratchet strap (S). Once disengaged, allow the looped ratchet strap (S) to hang down freely. Note: Do not shift your weight around or hang over the side of the platform area while disengaging the straps.

STEP 2: Disconnect your full-body fall arrest harness and slowly and carefully climb down the ladder stand. Be careful not to shift your weight around while climbing down. NEVER stand/kneel/lean on or against the seat or foot platform while removing the looped ratchet strap (S) from the tree.

STEP 3: When safely back on the ground, carefully remove the 8' stabilizing rope (U) and adjustable support bar assembly (V) from the tree and ladder rung. Next, disconnect the previously installed 16' stabilizing ropes (T) from the ladder rung.

Note: NEVER walk or stand under the ladder stand at any time during set-up or removal of any treestand.

STEP 4: With the assistance of three (3) or more adults, carefully and slowly walk the ladder stand down to the ground. Make certain to have someone behind the tree holding onto the 16' stabilizing ropes (T) to help control the lowering rate of the treestand to the ground while one (1) person is on each side of the ladder sections to aide in the lowering of the ladder stand.

Note: Do not allow the unit to fall to the ground. NEVER walk, stand, or hold the ladder stand in the same path of the treestand being lowered to the ground. DO NOT flex the ladder sections while raising/lowering any treestand. This will put stress on the ladders causing them to bend.

STORAGE AND CARE

It is recommended that you store your treestand out of direct sunlight and out of any other harsh environmental condition(s) that may adversely affect its performance. Always apply a protective sealant or oil all hardware to prevent corrosion. Replace all straps and ropes annually. Store all seat cushions and pads in a cool dry place.