

Infrared Mobile Digital Scouting Camera

User's Manual *Covert Special Ops.*



Content

1	Instruction	1
1.1	General Description	1
1.2	Camera Body Interfaces	1
1.3	Remote Control	2
1.3.1	Navigating	2
1.3.2	Characters	2
1.4	Shooting Information Display	3
1.5	MMS function	3
1.6	Supported Format	4
2	Cautions	5
3	Quick Start Guide	Error! Bookmark not defined.
3.1	Power Supply	6
3.2	Insert the SD-card and the SIM-card	6
3.3	Power on and Enter into the ON Mode	6
3.4	Enter into the TEST Mode	7
3.4.1	Custom Settings	7
3.4.2	Manual Capturing	7
3.4.3	View Images or Videos	7
3.4.4	Send MMS	7
3.5	Power Off	7
4	Advanced Operations	8
4.1	Settings Menu	8
4.1.1	Default Setting	10
4.1.2	General Settings	Error! Bookmark not defined.
4.1.3	Set Camera Mode	10
4.1.4	Format SD-Card	10
4.1.5	Set Photo Size	11
4.1.6	Set Video Size	11
4.1.7	Set Date and Time	11
4.1.8	Set Photo Burst	12
4.1.9	Set Video Length	12
4.1.10	Set Video Sound	12
4.1.11	Set PIR Triggering Interval Time	12
4.1.12	Set PIR Sensitivity	13
4.1.13	Set Timer	13
4.1.14	Set Flash Range	13
4.1.15	MMS Settings	14
4.1.16	Set MMS Mode	14
4.1.17	Set Send to	15
4.1.18	Enter Password	15
4.1.19	Reset to Default Settings	15
4.2	Playback	16
4.2.1	Viewing Photo or Video	16
4.2.2	Delete Photo or Video	16
4.2.3	Send MMS Manually	16
4.3	Laser Pointer	17

4.4	File Numbering	17
4.5	Firmware Upgrade.....	17
	Appendix I : Technical Specifications.....	18
	Appendix II : Parts List.....	19

1 Instruction

1.1 General Description

This camera, a digital scouting camera with MMS function, is a digital infrared surveillance camera, triggered by any movement of humans or animals monitored by a high sensitive Passive Infrared (PIR) motion sensor, and then automatically captures high quality pictures (up to 5M pixels) or records video clips (VGA) according to default settings or preset customer settings. It will then send the pictures instantly to your mobile device or e mail via GSM/GPRS/MMS network. You'll be alerted just when the camera is triggered or per custom settings.

It takes color pictures or videos under sufficient daylight. While at night, the built-in infrared LED's take clear pictures or videos (monochrome).

There is a 1.5" color LCD display screen on the camera and a sound recorder embedded in the camera. A laser pointer is used to help target the photo area of the camera. It supports MMS/SMS/E-mail via GSM Network.

It is resistant against water and snow. The camera can also be used as a portable digital camera.

1.2 Camera Body Interfaces

The camera has the following I/O interfaces: USB connector, SD-card slot, TV output and external DC power connector.

On the back of camera, there is a lock for theft-proof and an adjuster to change the tilt when mounting on an irregular interface e.g. tree.

Take a few moments to familiarize yourself with the camera controls and displays. It is helpful to bookmark this section and refer to it when reading through the rest of the manual.

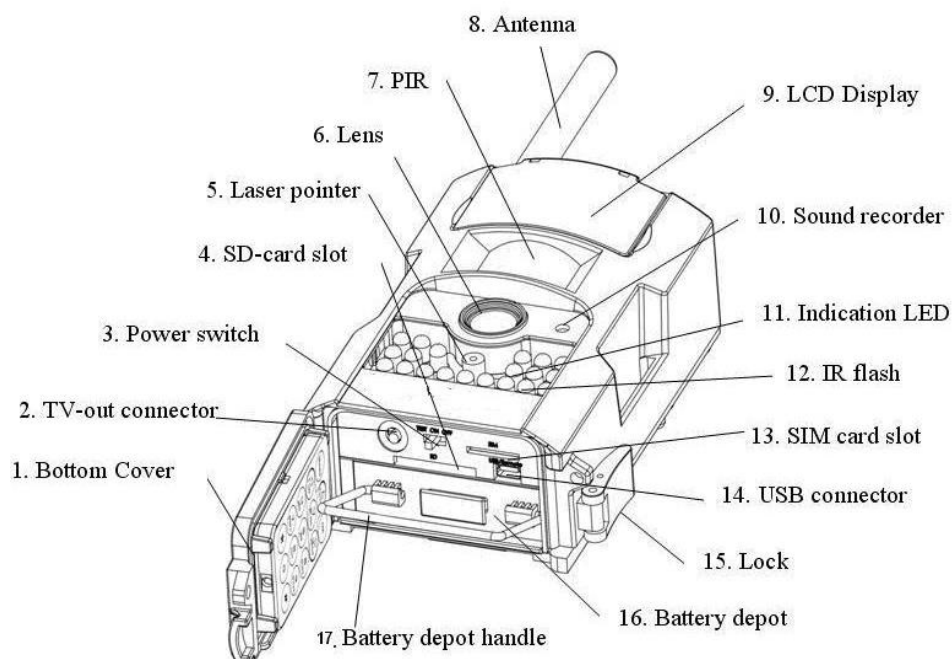

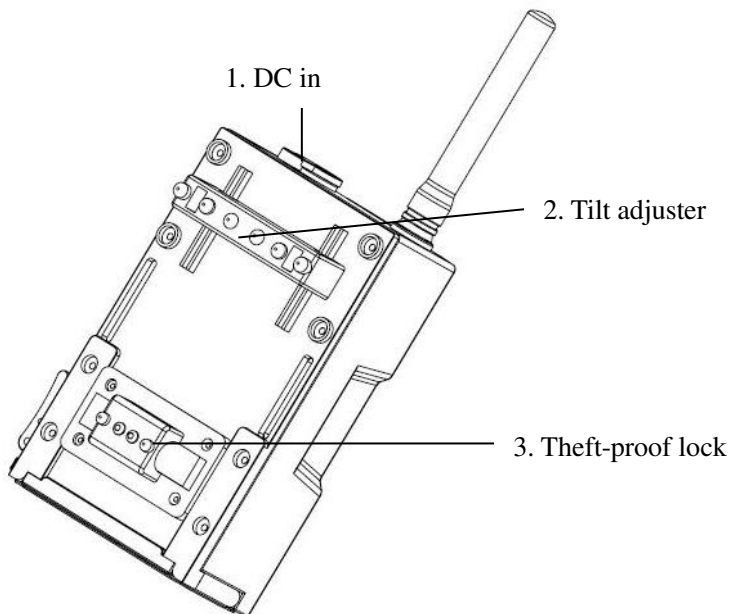

1.3 Remote Control

The remote control is the input device for the camera and is primarily used for customer settings and password input. This is an infrared type wireless remote control. The maximum remote distance is 30 feet.

There are fifteen buttons on the remote control.



1.3.1 Navigating

Press **UP** or **DOWN** to select or highlight the menu item. Press **LEFT** or **RIGHT** to select the option of each item and press **OK** to make a selection.

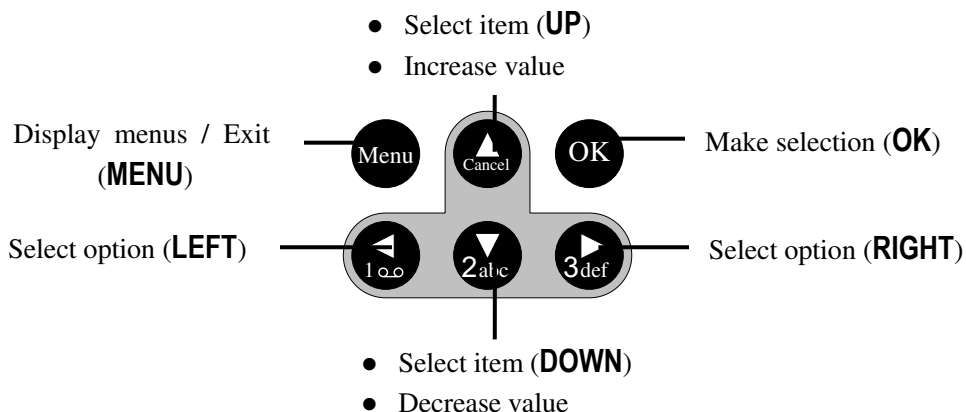

1.3.2 Characters

When entering digits, letters or punctuations into an input column, there are some useful characters that can be used by pressing the button continuously:

: 1 . / : @ _

: 0 + -

Press the punctuation “*” for laser pointer.

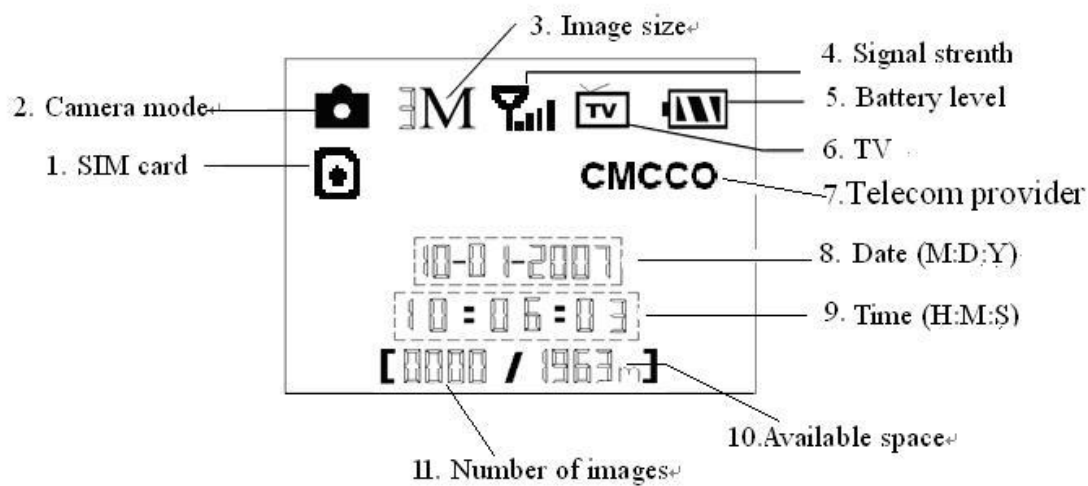

1.4 Shooting Information Display

When the camera is turned on (the power switch is slid to **ON** or **TEST** position), the current settings will be displayed on screen.



1.5 MMS function

This camera can send pictures instantly to your mobile device via GSM/GPRS network. You'll be alerted just when a picture or video has been taken. The camera sends MMS message through GPRS network, so before using this function, you need to open GPRS service from your service provider. It supports four band : 850MHz, 900MHz, 1800MHz and 1900MHz. For related information, please refer to section 4.1 setting menu table “MMS mode” and 4.1.15 MMS settings.

SIM card Icon: There are two SIM card icons which stand for different installation situations.  means the SIM card is inserted and it works well.  means the MMS function can't work correctly because of loss of signal or other communication issues. If the SIM card is not inserted, no SIM card icon will be displayed.

Be sure that the PIN of the SIM card is disabled before inserting the SIM card. (You can disable the PIN of a SIM card via your mobile phone.)

There are 3 submenu settings within the MMS function. They are **MMS Mode**, **MMS Set** and **Send to**. **MMS Mode** means to choose a way to send MMS (refer to 4.1 table). **MMS Set** means to have the right MMS setting parameters according to

your network. **Send to** means to input the phone number or email address which you want to send to. All 3 submenus must be correctly set up.

1.6 Supported Format

Item	Format
Photo	JPG
Video	AVI
File format	FAT32

Here are some important notices. The file system format is not a concern of the camera unless you have problems with reading the SD-card with other devices. If this happens, please format the SD-card in the camera or in a computer and then reinsert the card into your camera.

2 Cautions

- ★ The working voltage of the camera is 6V. The camera is supplied by four or eight AA batteries.
- ★ Please install batteries according to shown polarity.
- ★ Please unlock the write-protect before inserting the SD-card.
- ★ Please insert the SD-card when the power switch is in the **OFF** position before testing the camera. The camera has no internal memory for saving images or videos. If no SD-card is inserted, the camera will shut down automatically after a continuous indication sound.
- ★ Please do not insert or take out the SD-card when the power switch is in the **ON** position.
- ★ It is recommended to format the SD-card by the camera when used for the first time.
- ★ The camera will be in USB mode when connected to a USB port of a computer. In this case, the SD-card functions as a removable disk.
- ★ In the **TEST** mode, the camera will shut down automatically after 3 minutes if no operation is done. Please turn on the power again if you want to continue to work with the remote.
- ★ Please ensure there is sufficient power when having a firmware upgrade, otherwise the upgrade process could be interrupted. If any fault occurs after an improper upgrading process, the camera may stop functioning properly.



3 Quick Start Guide

3.1 Power Supply

To supply power for the camera, four or eight size AA batteries are needed.

Open the bottom cover. Confirm that the power switch is in the **OFF** position and pull out the battery pack by pulling the silver handle. Load the fully charged batteries into the pack according the polarities signs shown below. Push the battery pack back into to the battery chamber. The following batteries with 1.5V output can be used:

1. High-density and high-performance alkaline batteries (Recommended)
2. Rechargeable alkaline batteries
3. Rechargeable NiMH batteries

There are four battery slots. Slot 1 and 2 form one group and is marked “1” while slot 3 and 4 form the other group and is marked “2”. Only one “group” of batteries is needed to supply power to the camera, but both can be used and is recommended.

When in a low-battery state, the camera will be automatically shut down after two indication sounds. Please change the batteries at this time. If you have set the MMS function, it will send you a MMS/SMS or Email to indicate the low battery situation.

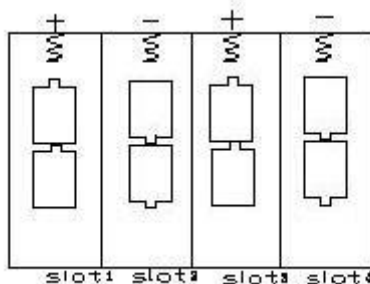

3.2 Insert the SD-card and the SIM-card

Open the bottom cover. Insert an SD-card into the card slot with unmarked side upwards. Please note that the SD-card is on the “write” (not locked) position otherwise the camera will not function correctly. When using MMS/SMS/E-mail functions, be sure to insert a SIM-card into the SIM-card slot with angle in the upper left.

3.3 Power on and Enter into the ON Mode

Before switching on, please pay attention to the following:

1. Avoid temperature and motion disturbances in front of the camera such as a big leaf, curtain, air-conditioner, air outlet of the chimney and other heat sources to prevent from false triggering.
2. The height from the ground for placing the camera should vary with the object size appropriately. In general, **three to six feet** is preferred.

Slide the power switch to the **ON** position to power on the camera and enter into the **ON** mode. Before entering into the ON mode, you can adjust the camera towards

the target monitoring area by laser pointer. See section 4.3. for related information.

After switching on the camera, the motion indication LED (red) light will blink for about 10s. The 10s is a buffering time before automatically capturing photos or videos, e.g. for closing and locking the bottom cover, fixing the camera on a tree and walking away.

In **ON** mode, it is unnecessary to use the remote control. The camera will take pictures or videos automatically according to the default settings or previous custom settings. The camera has the sound recording function, so the sound will be embedded in the video clip while capturing a video.

3.4 Enter into the TEST Mode

Slide the power switch to the **TEST** position and enter into the **TEST** mode. There are some functions in **TEST** mode: Custom settings, manual capture, preview or send MMS manually. The remote control is needed in this mode.

3.4.1 Custom Settings

Press **MENU** on the remote control to enter into the menu setting. The camera can be adjusted to manually customize the camera settings which display on the LCD screen on the camera or external TV monitor. The detailed operations will be described in the “Advanced Operations” chapter.

3.4.2 Manual Capturing

You can press **RIGHT** to manually capture photos or record a video.

3.4.3 View Images or Videos

There are two ways to view the captured images or videos:

1. LCD screen on camera
2. TV monitor which connects to the camera with a TV cable

Press **OK** to view images, the latest image will be shown in the LCD screen on the camera or TV monitor. Press **UP** to view the previous image and press **DOWN** for the next image. Please note that a video cannot be played back on the LCD screen and only the thumbnail of the video is showed.

The detailed operations like deleting images or videos will be described in the “Advanced Operations” chapter.

3.4.4 Send MMS

When the MMS Mode is set as “Manual”, you can send the selected photo to the preset address in TEST mode.”Daily Report” and “Instant” mode are used in the ON mode.

3.5 Power Off

Slide the power switch to the **OFF** position to power off the camera. Please note that even in the **OFF** mode, the camera still consumes a small amount of battery power. Therefore, please remove the batteries if the camera is not in use for a length of time.

4 Advanced Operations

From the basic operations of the camera previewed in the previous chapter, we know that the camera has three basic operation modes:

1. **OFF** mode: Power switch is in the **OFF** position.
2. **ON** mode: Power switch is in the **ON** position.
3. **TEST** mode: Power switch is in the **TEST** position.

In the above three modes, the **OFF** mode is the specified safe mode when replacing the SD-card or batteries and transporting the camera.

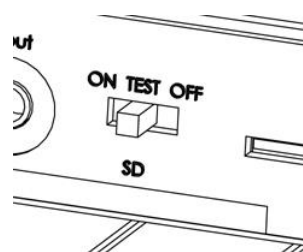

This chapter explains the advanced operations for customizing the camera settings. The settings can only be customized in **TEST** mode and the wireless remote is needed.

4.1 Settings Menu

To view the camera settings menu, press **MENU** in the **TEST** mode (called settings menu in this chapter). The settings menu will be shown on the LCD on camera or the external TV monitor. There are seventeen items of menu settings:

Setting Items	Description
Camera Mode	Choose capturing images or recording videos.
Format	Format the SD-card. All images and videos in the SD-card will be deleted.
Photo Size	Choose the image size, e.g. 5 mega pixels.
Video Size	Choose the video size, e.g. 640×480 (VGA).
Set Clock	Set camera date and time.
Photo Burst	Choose the continuous shooting numbers after each triggering.
Video Length	Choose duration of recording video.
Video Sound	Choose if the sound recorder will be used.
Interval	Choose how long the camera will stop functioning after each triggering. The camera's PIR will be disabled during this interval.
Sense Level	Choose sensitivity of the PIR. The camera PIR is strongly related to the temperature. On high, the camera will trigger more easily. Therefore we recommend the High setting for temperatures exceeding 95 degrees Fahrenheit. Use the Low setting for temperatures below 35 degrees Fahrenheit to reduce false triggers. For normal use of the camera, the Normal mode is recommended and is the default setting.
Timer	The camera can be set to only record/capture at a certain time of the day when set to On . The rest of the time the camera will be shut off and will not record any triggers set off by movement. This function can be set to Off and will function to the interval settings.
Flash Range	Infrared Flash range: .20 ft./6m and 40 ft./12m

<p>MMS Set</p>	<p>The camera sends MMS message through GPRS network, so before using this function, you need to open GPRS service from your service provider. It supports four bands : 850MHz, 900MHz, 1800MHz and 1900MHz.</p> <p>You should set the right MMS setting parameters. The settings of MMS: URL, APN, IP and Port. Please contact the network service provider if you are not familiar with the settings.</p>
<p>MMS Mode</p>	<p>There are 3 MMS modes: “Manual” works in TEST mode, “Daily report” and “Instant” work in ON mode.</p> <p>1)“Manual”:</p> <p>Choose “Manual” in Test mode. Please ensure a SIM card is inserted properly; Please note, only photos can be sent in TEST mode .Video information can’t be sent in TEST mode.</p> <p>2)“Daily Report”:</p> <p>Daily Report works only in the ON mode, which means that the camera will report the summarized information at the preset time (if the preset time is, eg.20:00PM) on how many pictures it had taken per day. So, you will get a summarized text message with the last picture taken until 20:00PM.</p> <p>If it is on Camera mode, the camera will send a MMS at the preset time. The MMS will show you the latest photo and the total qty of the pictures get taken. If it is on Video mode, the camera will send a SMS at the preset time. The SMS will show you how many video clips the camera has taken within 24 hours.</p> <p>3) “Instant”:</p> <p>Instant, just works in ON mode, which means the camera will send a MMS instantly after it captures a photo or a video clip. While, for the economy consideration, there is a limitation on the MMS quantity per day. You can set the MAX number from 0 to 99.</p> <p>If it is on Camera mode and you chose the Instant MMS mode, and set the MAX number is 10, the camera will send 10 MMS within 24 hours .And then it continues to capture photos and save them on the SD-card. After 24 hours, the camera will send MMS again when it captures photos. If it is on Video mode, the Camera will send only SMS instead of MMS.</p> <p>4) “OFF”:</p>
<p>Send To</p>	<p>Enter the phone number or email where the MMS is to be sent. There is a maximum of four numbers or four emails to be sent at the same time.</p> <p>1> Number: press “#” in between each input;</p> <p>2> Email: see 1.3.2 for punctuation information;</p> <p>3> Both: ensure there is at least one phone number and one email address.</p>

Password	For safety purposes, enter a password each time when entering into Test mode. The default password is 0000. You could choose OFF to stop this function.
Default Set	Restore all customer settings to default values.

4.1.1 Default Setting

Defaults settings are listed below:

Setting Items	Default	Options	Submenu
Camera Mode	Photo	Video	
Format	Enter		Yes, No
Photo Size	3M Pixel	5M Pixel	
Video Size	640×480	320×240	
Set Clock	Enter		Adjust Clock
Photo Burst	1 Photo	2 Photo, 3 Photo	
Video Length	Avi 10 sec	Avi 5–60 sec	
Video Sound	On	Off	
Interval	1 Min	5–60 seconds, 1-60 min	
Sense Level	Normal	High, Low	
Timer	Off	On	Start, Stop (00:00 – 23:59)
Flash Range	20ft./6m	40ft./12m	
MMS Set	Enter		URL, APN, IP, Port
MMS Mode	Manual	Manual, Daily Report, Instant	
Send To	Number	Email, Both	4 inputs
Password	OFF	ON	
Default Set			

4.1.2 Set Camera Mode

There are two modes: Camera or Video. There are two ways to set the camera mode: 1. Via shortcut key; 2. Via setting menu.

1. Shortcut key: Press **UP** to set the camera mode as **Video** or press **DOWN** to set camera mode as **Photo** in info display of **TEST** mode.
2. Setting menu: The following shows how to set camera mode to **Video**, provided that the previous option is **Photo**:
 - a) Press **MENU** to display the setting menu.
 - b) Press **UP** or **DOWN** to select **Camera Mode**.
 - c) Press **LEFT** or **RIGHT** to select **Video**.
 - d) Press **OK** to save the current setting and the option will be un-highlighted. Press **MENU** to cancel setting and return to info display.

4.1.3 Format SD-Card

The system will delete all images or videos stored in the SD-card after formatting, so make sure that you have made a backup of important data.

- a) Press **MENU** to display the setting menu.
- b) Press **UP** or **DOWN** to select **Format**.
- c) Press **OK** to choose **Enter** to enter into submenu.
- d) Press **LEFT** or **RIGHT** to select **Yes**. **Yes** will be highlighted.
- e) Press **OK** to start formatting the SD-card. During formatting, the display screen will show a message “Please Wait” as below.
Press **MENU** to cancel setting and return to info display.

Please Wait!

4.1.4 Set Photo Size

This parameter has two values: 5 mega pixels (5M Pixel or 5MP) and 3 mega pixels (3M Pixel or 3MP). The default value is 5 mega pixels. The following shows how to set pixel size as **3M Pixel** provided that the previous option is **5M Pixel**:

- a) Press **MENU** to display the setting menu.
- b) Press **UP** or **DOWN** to select **Photo Size**.
- c) Press **LEFT** or **RIGHT** to select **3M Pixel**.
- d) Press **OK** to save the current setting and the option will be un-highlighted.
Press **MENU** to cancel setting and return to info display.

4.1.5 Set Video Size

This parameter also has two values: VGA (640×480) and QVGA (320×240) . The default value is “640x480” (VGA). The following shows how to set video size as **320×240** provided that the previous option is at **640×480**:

- a) Press **MENU** to display the setting menu.
- b) Press **UP** or **DOWN** to select **Video Size**.
- c) Press **LEFT** or **RIGHT** to select **320×240**.
- d) Press **OK** to save the current setting and the option will be un-highlighted.
Press **MENU** to cancel setting and return to info display.

4.1.6 Set Date and Time

You can change the date and time of the device by setting this parameter when necessary, e.g., after every battery change. The date format is **month/day/year**, the time format is **hour: minute: second**. The valid value for year is between 2009 and 2050.

Provided that the date and time are needed to be set to November 15th, 2010 and 10:30, the steps are as following:

- a) Press **MENU** to display the setting menu.
- b) Press **UP** or **DOWN** to select **Set Clock**.
- c) Press **OK** to **enter** into submenu.
- d) Press **LEFT** or **RIGHT** to select item, press **UP** or **DOWN** to change the value.
- e) Press **OK** to save all current setting and return to info display.

Press **MENU** to cancel setting and return to info display.

4.1.7 Set Photo Burst

This parameter affects the number of pictures taken for each triggering in the camera mode. It has three values: “1 Photo” “2 Photos” and “3 Photos”. Its default value is “1 Photo”. The following shows how to set photo burst to **3 Photos**, provided that the previous option is **1 Photo**:

- a) Press **MENU** to display the setting menu.
- b) Press **UP** or **DOWN** to select **Photo Burst**.
- c) Press **LEFT** or **RIGHT** to select **3 Images**.
- d) Press **OK** to save the current setting and the option will be un-highlighted.
Press **MENU** to cancel setting and return to info display.

4.1.8 Set Video Length

This parameter is effective and can be adjusted only when the device in the video mode under ON mode. Its value extends from 1 to 60 seconds with a step of one second. The default value is 10 seconds. Press **LEFT** and **RIGHT** to decreases or increases the value by 1 second.

The following shows how to set video length to **5 Seconds** provided that the previous value is **10 Seconds**:

- a) Press **MENU** to display the setting menu.
- b) Press **UP** or **DOWN** to select **Video Length**.
- c) Press **LEFT** or **RIGHT** to decrease or increase to **5 Seconds**.
- d) Press **OK** to save the current setting and the option will be un-highlighted.
Press **MENU** to cancel setting and exit.

4.1.9 Set Video Sound

The following shows how to set video sound as off that the previous option is on:

- e) Press **MENU** to display the setting menu.
- f) Press **UP** or **DOWN** to select **Video Sound**.
- g) Press **LEFT** or **RIGHT** to select **off** or **on**.
- h) Press **OK** to save the current setting and the option will be un-highlighted.
Press **MENU** to cancel setting and return to info display.

4.1.10 Set PIR Triggering Interval Time

This parameter indicates how long the PIR (Passive Infrared motion sensor) will be disabled after each triggering in ON mode. During this time the PIR of the device will not react to the motion of human (or animals). The minimum interval is 0 seconds, it means the PIR works all the time. The maximum interval is 1 hour. It means the PIR will be disabled for 1 hour after each triggering. The default value is 1 minute. Press **LEFT** or **RIGHT** to decrease or increase the value by 5s or 1 minute.

The following shows how to set triggering interval time to **5 Minutes** provided that the previous value is **1 Minute**.

- a) Press **MENU** to display the setting menu.
- b) Press **UP** or **DOWN** to select **Interval**.
- c) Press **LEFT** or **RIGHT** to decrease or increase to **5 Minutes**.

- d) Press **OK** to save the current setting and the option will be un-highlighted.
Press **MENU** to cancel setting and return to info display.

4.1.11 Set PIR Sensitivity

This parameter defines the sensitivity of the PIR. There are three parameters: High, Normal, and Low. The default value is “Normal”. The higher degree indicates that the Camera is more easily to be triggered by motion, taking more pictures or recording more videos. It is recommended to use high sensitivity degree in room or environment with little interference, and to use lower sensitivity for outdoor or environment with lots of interference like hot wind, smoke, near window etc. Furthermore, the sensitivity of the PIR is strongly related to the temperature. Higher temperature leads to lower sensitivity. Therefore it is suggested to set a higher sensitivity for high temperature environment. It is recommended to use the “Low” setting for temperatures below 35 degrees Fahrenheit and the “High” setting for temperatures exceeding 95 degrees Fahrenheit.

The following shows how to set PIR sensitivity as **Low** provided that the previous option is **Normal**.

- a) Press **MENU** to display the setting menu.
- b) Press **UP** or **DOWN** to select **Sense Level**.
- c) Press **LEFT** or **RIGHT** to select **Low**.
- d) Press **OK** to save the current setting and the option will be un-highlighted.
Press **MENU** to cancel setting and return to info display.

4.1.12 Set Timer

This parameter defines a certain time lapse in a day when the Camera can be triggered. The rest of the time the device is shut off. The effective value for the ranges from 00:00: 00 to 23:59:59.

Please note that the start and stop time can only be effective when the timer is set as **On**. Provided that the camera should work from eight a.m. to five p.m., the steps are as following:

- a) Press **MENU** to display the setting menu.
- b) Press **UP** or **DOWN** to select **Timer Switch**.
- c) Press **RIGHT** to select **On**.
- d) Press **OK** to enter into submenu.
- e) Press **RIGHT** to select item, press **UP** or **DOWN** to change the value until the start time changes to 8 and the stop time changes to 17.
- f) Press **OK** to save all current setting and the option will be un-highlighted.
Press **MENU** to return to previous menu.

4.1.13 Set Flash Range

This parameter defines how many IR lights will work when the sunlight is not enough. If you choose **12m**, it means the 34 IR lights will all work. .If you choose **6m**, it means only the outside two lines IR lights will work and the power consumption will be smaller. The following shows how to set flash range as **6m** provided that the

previous option is **12m**.

- i) Press **MENU** to display the setting menu.
- j) Press **UP** or **DOWN** to select **Flash Range**.
- k) Press **LEFT** or **RIGHT** to select 20 ft./6m or 40 ft./12m.
- l) Press **OK** to save the current setting and the option will be un-highlighted.
Press **MENU** to cancel setting and return to info display.

4.1.14 MMS Settings

Enter the MMS setting which provided by the network service provider. There are **only** four setting to be entered, the steps are as follows:

- a) Press **MENU** to display the setting menu.
- b) Press **UP** or **DOWN** to select **MMS Set**.
- c) Press **OK** to **Enter** into submenu.
- d) There are four inputs for key in **URL**, **APN**, **IP** and **Port**, press **#** to switch between each inputs. Press number buttons to key in the digits, letters or punctuations. Press **UP(Cancel)** to delete.
- e) Press **OK** to save all current setting and return to info display.
Press **MENU** to cancel setting and to return to previous menu.

Easy Access to MMS setting (edit in the computer)



1. Load the fully charged batteries.
2. Insert SD card.
3. Insert SIM card.
4. Power on and entering into the **TEST** Mode.
5. A new file named '**PROFILE.INI**' is created automatically in a new folder named '**MMS**' in the SD card.
6. Reedit the file '**PROFILE.INI**' in the computer to set the MMS parameters, below is for reference:
URL: (Max. 64 characters)
A.P.N: (Max. 32 characters)
IP: (Max. 16 characters)
Port: (Max. 6 characters)
Account and Password :(Some telecom operators need to set account and password to launch MMS.)
Number: (Max. 24 characters for each phone number)
Email: (Max. 48 characters for each email)

Please note that this is only an example, for more details please contact your network service provider, and there are only 4 parameters needs to be edited, do not change other parameters expect these 4 parameters to avoid operation failure.

4.1.15 Set MMS Mode

There are 3 MMS modes: “Manual” works in TEST mode. “Daily report” and “Instant” work in ON mode. For more information, please refer to 4.1 settings menu.

The following shows how to set the MMS mode to **Instant** provided that the previous option is **Off**:

- a) Press **MENU** to display the setting menu.
- b) Press **UP** or **DOWN** to select **MMS Mode**.
- c) Press **LEFT** or **RIGHT** to select **Instant**.
- d) Press **OK** to save the current setting and the option will be un-highlighted.

Press **MENU** to cancel setting and return to info display.

If you choose “Daily Report”, you need to set the daily report time: xxH, xxM.

If you choose “Instant”, you need to set how many MMS you want to send for economy consideration. You can choose 0 to 99 pictures.

4.1.16 Set Send to

Enter the phone number or email which the MMS to be sent to. The following shows how to set up sending to **Number** provided that the previous option is **Email**:

- a) Press **MENU** to display the setting menu.
- b) Press **UP** or **DOWN** to select **Send To**.
- c) Press **LEFT** or **RIGHT** to select **Number**.
- d) Press **OK** to enter into submenu.

Press **MENU** to cancel setting and return to info display

- e) There are four inputs, press **#** to switch between each input. Press number buttons to key in the digits, letters or punctuations. Press **UP** to delete.
- f) Press **OK** to save all current setting and return to info display.

Press **MENU** to cancel setting and to return to previous menu.

4.1.17 Enter Password

If the password setting is selected as **On**, after switching on the camera, the LCD screen on camera will prompt to enter a password. The default password is 0000. Please key in the password by using the remote control. It can be changed using the following steps:

- a) Press **MENU** to display the setting menu.
- b) Press **UP** or **DOWN** to select **Password**.
- c) Press **LEFT** or **RIGHT** to select **On**.
- d) Press **OK** to enter into submenu.
- e) There are three inputs for key in new, old and confirm password, press **#** to switch between each inputs. Press number buttons to key in the digits. Press **UP** to delete.
- f) Enter **OK** to save all current setting and return to info display. If the inputs are blank, the password will not be changed; if keyed in correctly, the new password is set. The LCD screen will prompt to enter the password next time you switch on the camera.

Press **MENU** to cancel setting and return to previous menu.

4.1.18 Reset to Default Settings

To reset the setting to the default values, the steps are as follows:

- a) Press **MENU** to display the setting menu.
- b) Press **UP** or **DOWN** to select **Reset**.

- c) Press **OK** to reset to default settings and return to info display.
Press **MENU** to cancel setting and return to info display.

4.2 Playback

In playback mode, images or videos can be viewed and deleted. An image can also be manually sent by MMS. It can only be done in **TEST** mode.

The images can be viewed on the LCD screen on camera and TV monitor which connect to the camera with a TV cable; the videos can only be viewed on a TV monitor. For simplicity, operations with PC won't be introduced here.

4.2.1 Viewing Photo or Video

- a) Switch to **TEST** mode and enter into info display.
- b) Press **OK** to view the latest picture (or video) in LCD screen on camera, TV monitor or Image viewer with TV-in connector.
- c) Press **RIGHT** to start playing the video clip on the TV monitor; a video clip cannot be played in LCD screen on camera.
- d) Press **RIGHT** to stop playing and return to playback mode.
- e) Press **UP** to view the next picture (or video) and **DOWN** for the previous.
- f) Press **OK** to return to info display.

When viewing images, the total number of all images on the SD-card will be shown as well as an index of the displaying image.

4.2.2 Delete Photo or Video

- a) View the image (or video) which to be deleted (please refer to 4.3.1).
- b) Press **MENU** to display the playback menu.
- c) Press **UP** or **DOWN** to select **Delete**. **One** is highlighted.
- d) To delete the current image, just skip this step. To delete all images and videos, press **LEFT** or **RIGHT** to select **All**.
- e) Press **OK**, **No** and **Yes** are prompted. **No** is highlighted.
- f) Press **LEFT** or **RIGHT** to highlight **Yes**.
- g) Press **OK** to delete the image or video.
Press **MENU** to cancel and return to playback.

Please note that after deleting a picture or a video file, the deleted files can't be restored! Furthermore, in order to delete all images and video clips in the SD-card, it is suggested to format the SD-card. Please refer to 4.2.4.

4.2.3 Send MMS Manually

The **Send MMS** option will only be shown when the setting item **MMS Mode** is selected as **Manual**.

- a) View the images and select one to send.
- b) Press **MENU** to display the playback menu.
- c) Press **UP** or **DOWN** to select **Send Message**. **Send** is highlighted
- d) Press **OK** to send MMS according to the setting in setting menu.
Press **MENU** to cancel and return to playback.

Please note that the images can only be sent and video cannot be sent. If the SIM card is not inserted, the image cannot be sent as well.

4.3 Laser Pointer

The laser light pointer beam can be turned on as an additional function for pointing to an object or a certain region of interested (ROI).

Press ***** to turn on the laser light in **TEST** mode and use the tilt adjuster on the back of camera to adjust the angle of capturing direction.

NOTE:



Please note that the laser could be harmful to the eyes if pointed at another person.

4.4 File Numbering

Images and videos are saved in the pre-named folder. File numbering continues by adding one to the last number for each new image or video. Saving names are IMAG0001.JPG or IMAG0001.AVI. Through the suffix you can distinguish whether the file is an image (with suffix .jpg) or a video (with suffix .avi).

4.5 Firmware Upgrade

This camera is equipped with an automatic upgrade function for you. Upgrading is needed only when an improved firmware is available.

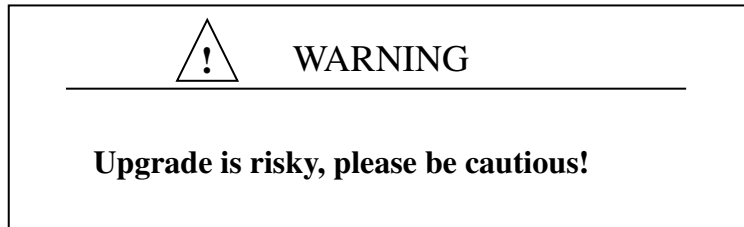

Appendix I : Technical Specifications

Image Sensor	5MP Color CMOS
Lens	F/NO=3.0 FOV(Field of View)=52°
IR-Flash	6-12m
Display Screen	1.5" LCD
Memory Card	From 8 MB to 16 GB
Picture Resolution	5MP = 2560×1920 3MP = 2048×1536
Video Resolution	640×480 (16fps) 320×240 (20fps)
PIR Sensor	Multi Zone
PIR Sensitivity	Adjustable (High/Normal/Low)
Trigger Time	1.2s
Weight	0.30 kg
Operation/Storage Tem.	-20 - +60°C / -30 - +70°C
Interval	1s – 60 min.
Photo Burst	1–3
Video Length	1–60s
Power Supply	8×AA or 4×AA
Stand-by Current	< 0.25 mA (<6mAh/Day)
Power Consumption	400 videos (interval=5min,video length=10s) ; >500 MMS(use 8*AA batteries)
Low Battery Alert	LED Indicator
Display Screen	LCD display on camera
Sound Recording	Available
Mounting	Rope/Belt/Python lock
Dimensions	140 x87 x55 mm
Operation Humidity	5% - 90%
Security authentication	FCC, CE, RoHS

*without battery

Appendix II : Parts List

Part Name	Quantity
Digital Camera	One
Wireless Remote Control	One
USB Cable	One
TV cable	One
Belt	One
User Manual	One
Antenna	One