

Infrared Digital Scouting Camera
User's Manual
Covert Extreme
Covert Extreme TLV (optional)



Content

1	Instruction	1
1.1	General Description	1
1.2	Application	1
1.3	Camera Interface	1
1.4	Saving Images or Videos	3
2	Cautions	4
3	Quick Start Guide	Error! Bookmark not defined.
3.1	Power Supply	5
3.2	Insert the SD-card	5
3.3	Power on and Entering into the ON Mode	5
3.4	Enter into the TEST Mode	5
3.4.1	Preview	5
3.4.2	Customer Settings	6
3.4.3	Manual Capturing	6
3.4.4	View Images or Videos	6
3.4.5	Delete Images or Videos	6
3.6	Power Off	7
4	Advanced Operations	8
4.1	Settings Menu	8
4.1.1	Set Camera Mode	8
4.1.2	Format SD-Card	8
4.1.3	Set Photo Size	8
4.1.4	Set Video Size	9
4.1.5	Set Date and Time	9
4.1.6	Set Photo Burst	9
4.1.7	Set Video Length	9
4.1.8	Set PIR Sensitivity	10
4.1.9	Set PIR Triggering Interval	10
4.1.10	Set Timer Triggering Interval	11
4.1.11	Set Timer Switch	11
4.1.12	Set Flash Range	11
4.1.13	Set Time Stamp	12
4.1.14	Reset to Default Settings	12
4.2	Default Settings and Live Monitoring	12
4.3	Firmware upgrade	12
5	Mounting the Camera	13
	Appendix I : Technical Specifications	14
	Appendix II : Parts List	15

1 Instruction

1.1 General Description

The Covert Extreme is a digital infrared surveillance camera, triggered by any movement of humans or animals monitored by a high sensitive Passive Infrared (PIR) motion sensor, and then automatically captures high quality pictures (up to 5M pixels) or records video clips (VGA) according to default settings or preset customer settings.

It also can be triggered by timer which means the camera can capture pictures or video clips at specified time intervals regardless of if there is a motion of human or animals. (This is only for the TLV version if equipped.)

It takes color pictures or videos under sufficient daylight. During the night, the built-in infrared LEDs function as the flash. The camera then takes clear black and white pictures or videos (monochrome).

The camera consumes very little power in the surveillance mode. Powered by Eight new AA alkaline batteries, the camera will stand-by for approximately 6 months. Once a motion by human or animals is detected, the digital camera unit will automatically take pictures or videos according to previously programmed settings.

The device is designed for outdoor use and is resistant against water and snow. Furthermore, the camera can be used as a portable digital camera. Pictures or videos can be taken manually by pressing  on the operation panel.

1.2 Application

This camera can be used as an automatic surveillance device for guarding and recording unexpected intrusion to homes, shops, schools, offices, cabins, private property, worksites etc. It can also be used as a trail camera for hunting or monitoring animals by recording the traces of wild animals. It can be left alone for weeks and months and it will deliver event records automatically in digital format to the SD card.

1.3 Camera Interface

1.3.1 Camera Body Interface

The camera has the following interfaces: a 2.0" TFT LCD display screen, operation panel, USB connector, SD-card slot, TV output and external DC power connector. Fig.1 shows the front view of the camera and its function parts. Fig.2 shows the operation panel and display screen. Fig.3 shows the bottom view of the camera and its I/O interface.

Take a few moments to familiarize yourself with the camera controls and displays. It is helpful to bookmark this section and refer to it when reading through the rest of the manual.

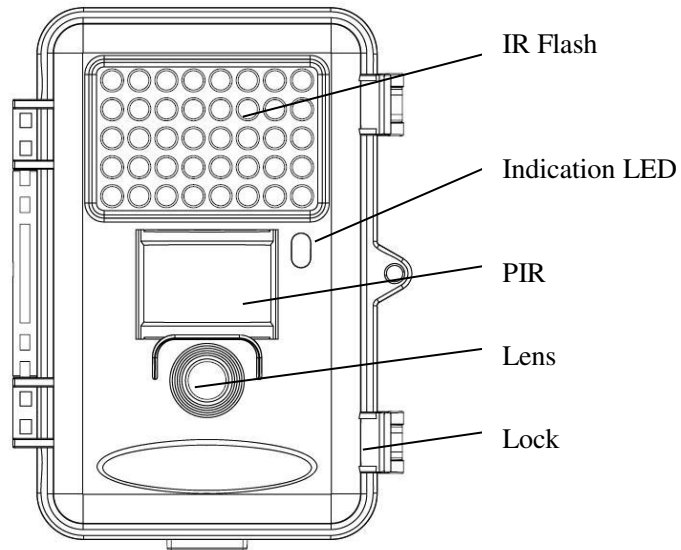

Figure 1: Front view

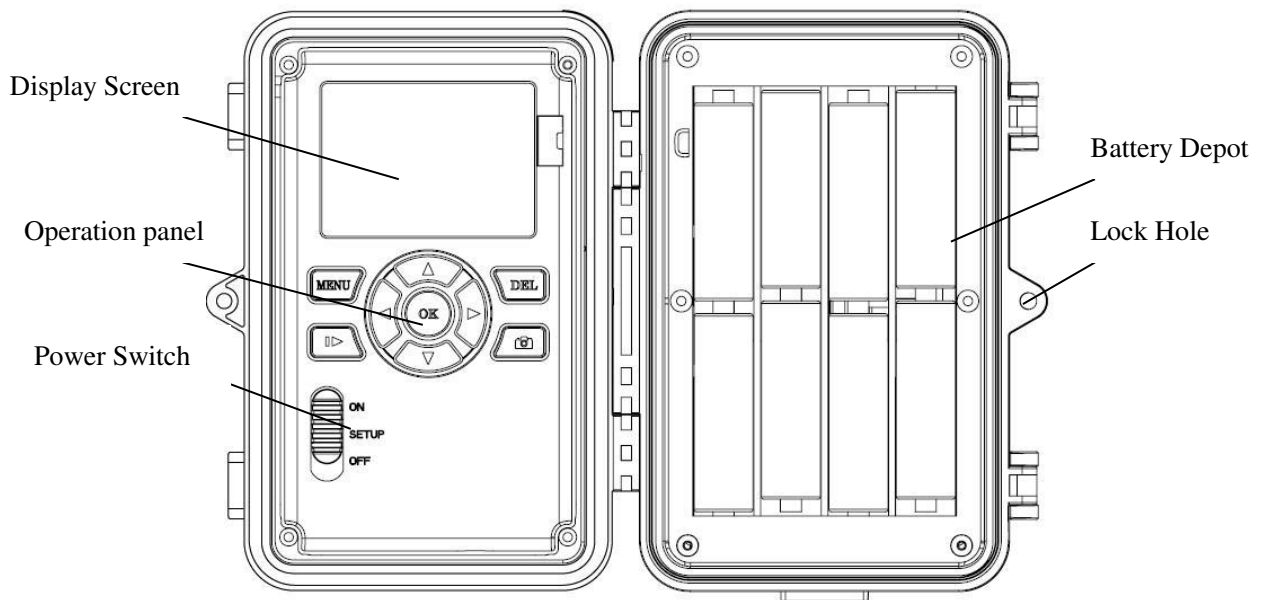

Figure 2: Operation interface

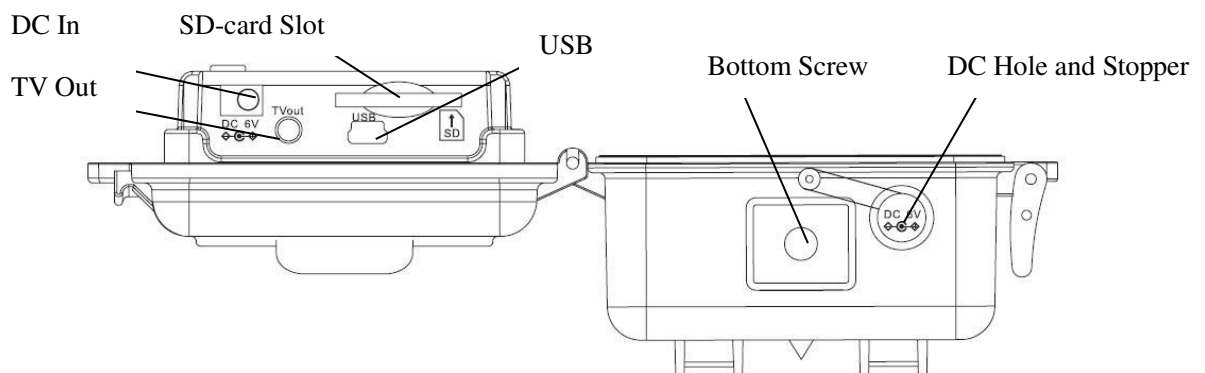

Figure 3: Bottom view

1.3.2 Key Notes

“MENU” : to enter the program menu in preview mode;

“▲”“▼”“◀”“▶” : for parameter settings as described in the user’s manual.

“OK” : to save parameter settings and play back videos.

“▶” : to exchange between playback mode and preview mode;

“DEL” : to delete an image

“📷” : to capture a photo or record a video manually.

1.3.3 Shooting Information Display

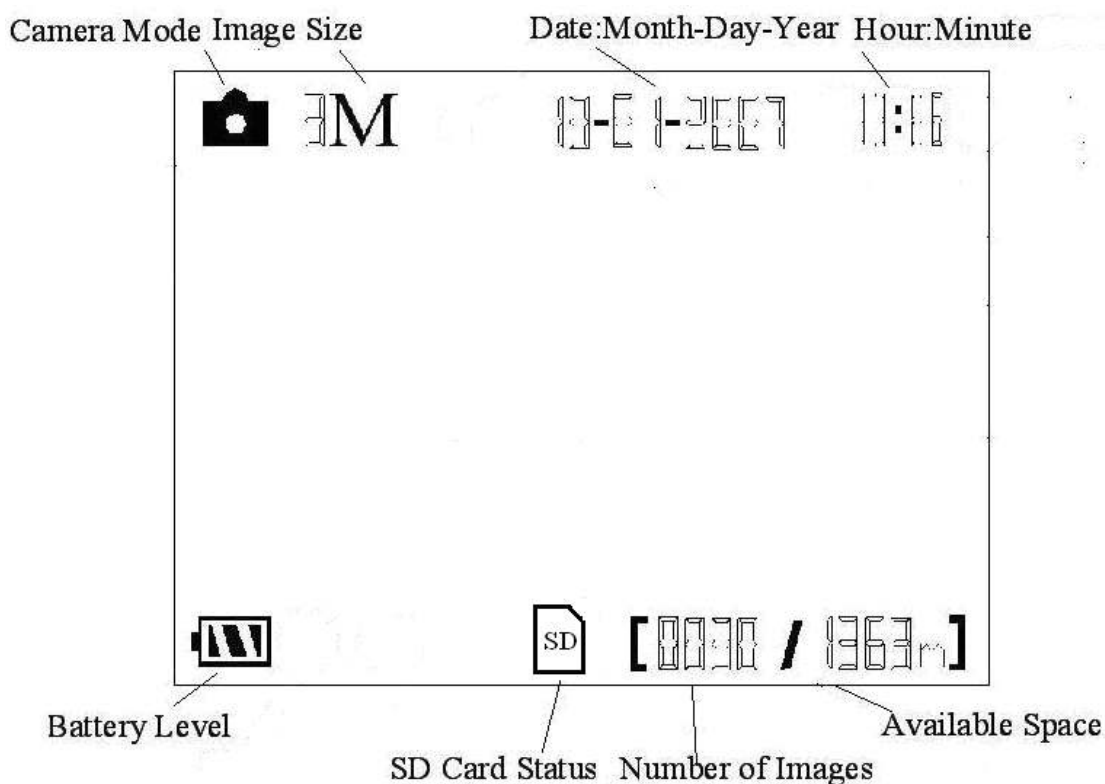

1.4 Saving Images or Videos

The Camera uses a SD-card to save images (in .jpg format) and videos (in .avi format). Before inserting the SD-card be sure that the SD card is unlocked. The camera is compatible with SD-card from 8MB to 8GB.

2 Cautions

- ★ The working voltage of the camera is 6V. The camera is supplied by four or eight AA batteries.
- ★ Please install batteries according to shown polarity.
- ★ Please unlock the write-protect before inserting the SD-card.
- ★ Please insert the SD-card when the power switch is at the **OFF** position before testing the camera. The camera has no internal memory for saving images or videos. If no SD-card is inserted, the camera will shut down automatically after a continuous indication sound.
- ★ Please do not insert or take out the SD-card when the power switch is at the **ON** position.
- ★ It is recommended to format the SD-card by the camera when used for the first time.
- ★ In the **SETUP** mode, the camera will shut down automatically after 3 minutes if no operation is done. Please turn on the power again if you want to continue working with the control.

3 Quick Start Guide

3.1 Power Supply

Use 8 or 4 AA batteries or 6v external battery for power supply.

Install the fully charged batteries into the depot according the polarities sign shown. The following batteries with 1.5V output can be used:

1. High-density and high-performance alkaline batteries (Recommended)
2. Rechargeable alkaline batteries
3. Rechargeable NiMH batteries

When in a low-battery state, the camera will be automatically shut down after the indication LED flashing warning is shown. Please change the batteries at this time.

3.2 Insert the SD-card

The camera has no internal memory for saving images or videos. If no SD-card is inserted or the SD-card is locked, the camera will not function properly.

3.3 Power on and Entering into the ON Mode

The Camera has three basic operation modes:

1. **OFF mode:** to turn off the camera.
2. **SETUP mode:** to set operational parameters, or to playback the photos or video clips via display screen or via TV.
3. **ON mode:** to work under surveillance state.

After switching the camera to the ON position, the motion indication LED (red) lights will blink for about 10s. This time interval is for you to make the Camera ready for automatic surveillance operation, e.g., to close the bottom cover and to lock it, to fix the camera on a tree and to walk away. After entering into the ON mode, no controls are needed nor is it possible to use in this mode. The Camera will take pictures or videos automatically according to the previous programmed settings, when human or animals enter into the monitoring region.

3.4 Enter into the SETUP Mode

There are 3 states in SETUP Mode: preview state (preview the scene in the front of the camera), setting state (make custom settings), and playback state (view Photos or videos via 2.0" TFT display).

(Note: Only the equipped Covert Extreme TLV model has the preview and playback option.)

3.4.1 Preview



After switching the camera to SETUP Mode, it enters into the preview state.

Press  to exchange between playback mode and preview mode;

3.4.2 Customer Settings

Press **MENU** to manually customize the camera settings which are displayed on the screen or external TV monitor. The detailed operations will be described in “Advanced Operations” chapter.

3.4.3 Manual Capturing

Press  to manually capture photos or record videos. Press again  to stop the manual capturing of a video.

3.4.4 View Images or Videos

There are two ways to view the captured images or videos:

1. LCD screen on the control
2. TV monitor which connect to camera with TV cable

Press  to view images or videos, the latest image or video will be shown in the LCD screen on the control or TV monitor. Press “▲” or “▼” to view the previous or next image or video.

3.4.5 Delete Images or Videos

Press **DEL** to delete images or videos. Note the **DEL** button just works in Playback state. So if it's in Preview state, you should press  to enter into the Playback state.

3.5 Triggering modes

There are 3 triggering modes of the camera: PIR triggering, Timer triggering and PIR & Timer triggering.

3.5.1 PIR Triggering

PIR triggering is the default setting. The camera works only when motions get detected. If the PIR sensitivity is set as **PIR OFF**, the camera stops PIR triggering.

3.5.2 Timer triggering

The **Timer interval** Default setting is **OFF** which means the timer triggering is disabled. While changing the timer triggering interval to a non-zero value, the camera starts to work at a preset interval. User need to **OFF** the PIR triggering (choose **PIR sensitivity** as **PIR OFF**) if want the camera work only via Timer triggering.

3.5.3 PIR & Timer triggering

If want both PIR triggering and Timer triggering, the user need go to **PIR sensitivity** to set “**normal, high or low**” sensitivities according to the external environments, and need to set the **Timer interval** to a desired non-zero value. The camera will capture pictures or videos in a preset time interval even there is no motions get detected; the camera will also capture pictures and videos if motions get detected. (Only in TLV version)

3.6 Power Off

Switch the camera to the **OFF** position to power off the camera. Please note that even in the **OFF** mode, the camera still consumes a certain amount of power. Therefore, please remove the batteries if the camera will not be used for a length of time.

4 Advanced Operations

After you're familiar with the basic operations of the Camera, you are now ready for advanced operations, and the options and parameters of the Camera are explained in more detail.

4.1 Settings Menu

To view the camera settings menu, press **MENU** in the **SETUP** mode (Power switch is at the **SETUP** position). The settings menu will be shown on the LCD on the camera or the external TV monitor (only when the camera is connected to a TV).

4.1.1 Set Camera Mode

There are two modes: Camera or Video. There are two ways to set the camera mode: 1. Via shortcut key; 2. Via setting menu.

1. Via shortcut key: You can set mode to "video" by pressing "▲" key and set mode to "camera" by pressing "▼" key in TEST mode.

2. Setting menu: The following shows how to set camera mode to **Video**, provided that the previous option is **Camera**:

- a) Press **MENU** to display the setting menu.
- b) Press "▲" or "▼" to select **Mode**.
- c) Press "▶" to select **Video**.
- d) Press **OK** to save the current setting and the option will be un-highlighted.
Press **MENU** to cancel setting and return to info display.

4.1.2 Format SD-Card

The system will delete all images or videos stored in the SD-card after formatting, so make sure that you have made a backup of important data.

- a) Press **MENU** to display the setting menu.
- b) Press "▲" or "▼" to select **Format**.
- c) Press **OK** to choose **Enter** to enter into submenu.
- d) Press "▶" to select **Yes**. **Yes** will be highlighted.
- e) Press **OK** to start formatting the SD-card. During formatting, the display screen will show a message "Formatting..." as below.
Press **MENU** to return to info display.

Formatting...

please wait
for format end

4.1.3 Set Photo Size

This parameter has two values: 5 mega pixels (5M Pixel or 5MP) and 3 mega pixels (3M Pixel or 3MP). The default value is 5 mega pixels.

The following shows you how to set pixel size as "3M Pixel" provided that the

previous value is “5M Pixel” at MENU state:

- a) Press **MENU** to display the setting menu.
- b) Press “▲” or “▼” to select **Photo Size**.
- c) Press “▶” to select **3MP**.
- d) Press **OK** to save the current setting and the option will be un-highlighted.
Press **MENU** to return to info display.

4.1.4 Set Video Size

This parameter also has two values: VGA (640×480) and QVGA (320×240) . The default value is “640x480” (VGA).

The following shows how to set video size as **320×240** provided that the previous option is **640×480**:

- e) Press **MENU** to display the setting menu.
- f) Press “▲” or “▼” to select **Video Size**.
- g) Press “▶” to select **320×240**.
- h) Press **OK** to save the current setting and the option will be un-highlighted.
Press **MENU** to return to info display.

4.1.5 Set Date and Time

You can change the date and time of the device by setting this parameter when necessary, e.g., after every battery change. The date format is **month/day/year**, the time format is **hour: minute: second**. The valid value for year is between 2009 and 2050.

Provided that the date and time are needed to be set to November 15th, 2010 and 10:30, the steps are as follows:

- a) Press **MENU** to display the setting menu.
- b) Press “▲” or “▼” to select **Set Clock**.
- c) Press **OK** to **enter** into submenu.
- d) Press “▶” to select item, press “▲” or “▼” to change the value.
- e) Press **OK** to save all current setting and return to info display.
Press **MENU** to return to info display.

4.1.6 Set Photo Burst

This parameter affects the number of pictures taken for each triggering in **Camera** mode. It has three values: “1 Photo” “2 Photos” and “3 Photos”. Its default value is “1 Photo”.

The following shows how to set continuous capture number to **3 Photos** provided that the previous option is **1 Photo**:

- a) Press **MENU** to display the setting menu.
- b) Press “▲” or “▼” to select **Capture Number**.
- c) Press “▶” to select **3 Photos**.
- d) Press **OK** to save the current setting and the option will be un-highlighted.
Press **MENU** to return to info display.

4.1.7 Set Video Length

This parameter is effective and can be adjusted only when the device in the video mode for the LIVE mode. Its value extends from 1 to 60 seconds with a step of one second. The default value is 10 seconds. Press “◀” and “▶” to decrease or increase the value by 1 second.

The following shows how to set video length to **15 Seconds** provided that the previous value is **1 Second**:

- a) Press **MENU** to display the setting menu.
- b) Press “▲” or “▼” to select **Video Length**.
- c) Press “▶” to increase to **15 Seconds**.
- d) Press **OK** to save the current setting and the option will be un-highlighted.
Press **MENU** to exit.

4.1.8 Set PIR Sensitivity

This parameter defines the sensitivity of the PIR. There are four parameters: **High**, **Normal**, **Low** and **PIR off**. The default value is “Normal”. The higher degree indicates that the Camera is more easily to be triggered by motion, taking more pictures or recording more videos. It is recommended to use high sensitivity degree in room or environment with little interference, and to use lower sensitivity for outdoor or environment with lots of interference like hot wind, smoke, near window. The sensitivity of the PIR is strongly related to the temperature. Higher temperature leads to lower sensitivity. Therefore we recommend the **High** setting for temperatures exceeding 95 degrees Fahrenheit. Use the **Low** setting for temperatures below 35 degrees Fahrenheit to reduce false triggers. For normal use of the camera, the **Normal** mode is recommended and is the default setting.

The following shows how to set the PIR sensitivity as **Low** provided that the previous option is **Normal**.

- a) Press **MENU** to display the setting menu.
- b) Press “▲” or “▼” to select **Sensitivity**.
- c) Press “▶” to select **Low**.
- d) Press **OK** to save the current setting and the option will be un-highlighted.
Press **MENU** to return to info display.

4.1.9 Set PIR Triggering Interval

This parameter means that how long the PIR (Passive Infrared motion sensor) will be disabled after each triggering in ON mode. During this time the PIR of the device will not react to the motion of human (or animals). The minimum interval is 0 seconds meaning the PIR works all the time. The maximum interval is 1 hour, meaning the PIR will be disabled for 1 hour after each triggering. The default value is 1 minute. Press “◀” and “▶” to decreases or increases the value.

The following shows how to set triggering interval time to **5 Minutes** provided that the previous value is **1 Minute**.

- a) Press **MENU** to display the setting menu.
- b) Press “▲” or “▼” to select **PIR Interval**.
- c) Press “▶” to decrease or increase to **5 Minutes**.
- d) Press **OK** to save the current setting and the option will be un-highlighted.

Press **MENU** to cancel setting and return to info display.

4.1.10 Set Timer Triggering Interval (TLV version only)

This TLV version is equipped with a timer function meaning the camera will capture images or videos at preset time intervals regardless of whether there are motions to detect or not. The default parameter is **OFF** which means the timer function is disabled. When changing this parameter to a non-zero value, it starts to take photos at the given time interval. The value ranges from 10 seconds to 8 hours. Press “◀” and “▶” to decrease or increase the value.

The following shows how to set timer interval to **1 hour** provided that the previous value is **OFF**.

- e) Press **MENU** to display the setting menu.
- f) Press “▲” or “▼” to select **Timer Interval**.
- g) Press “▶” to decrease or increase to **1 hour**.
- h) Press **OK** to save the current setting and the option will be un-highlighted.
Press **MENU** to cancel setting and return to info display.

4.1.11 Set Timer Switch

This parameter defines a certain time lapse in a day when the Camera can be triggered. In the rest of the time the device is shut off. The effective value of the hour ranges from 0 to 23 while the minute ranges from 0 to 59. Timer Switch OFF means the camera works all the time; Timer switch ON means the camera works only during the time lapse according to the preset settings.

Please note that the Timer switch functions only when the timer is set as **On**. Provided that the camera works from 08:00 a.m. to 17:00 p.m., the steps are as following:

- a) Press **MENU** to display the setting menu.
- b) Press “▲” or “▼” to select **Timer Switch**.
- c) Press “▶” to select **On**.
- d) Press **OK** to enter into submenu.
- e) Press “▶” to select item, press “▲” or “▼” to change the value until the start time changes to 8 and the stop time changes to 17.
- f) Press **OK** to save all current setting and the option will be un-highlighted.
Press **MENU** to return to previous menu.

4.1.12 Set Flash Range

This parameter defines the IR lights distance. The camera provides two options **15m** and **8m**. If set at 15m, all 40 of the IR lights work to get a long IR distance. If set at 8m, the IR range will be shorter, and only the 3 middle horizontal rows of IR lights work to save the power consumption.

The following shows how to set flash range as **8m** provided that the previous option is **15m**.

- a) Press **MENU** to display the setting menu.
- b) Press “▲” or “▼” to select **Flash Range**.
- c) Press “▶” to select **8m**.

- d) Press **OK** to save the current setting and the option will be un-highlighted.
Press **MENU** to cancel setting and return to info display.

4.1.13 Set Time Stamp

This parameter defines whether the date and time is stamped in the pictures and video clips or not. The following shows you how to set time stamp as “Off” provided that the previous value is “On” in MENU state.

- e) Press **MENU** to display the setting menu.
- f) Press “▲” or “▼” to select **Time Stamp**.
- g) Press “▶” to select **Off**.
- h) Press **OK** to save the current setting and the option will be un-highlighted.
Press **MENU** to cancel setting and return to info display.

4.1.14 Reset to Default Settings

To reset the setting to the default values, the steps are as follows:

- a) Press **MENU** to display the setting menu.
- b) Press “▲” or “▼” to select **Reset**.
- c) Press **OK** to reset to default settings and return to info display.
Press **MENU** to cancel setting and return to info display.

4.2 Default Settings and Live Monitoring

Please refer to table 1 for the default settings:

Parameter name	Default	Other settings
Camera Mode	Camera	Video
Photo Size	5M Pixel	3M Pixel
Photo Burst	1 Photo	2 Photos, 3 Photos
Video Size	640×480	320x240
Video Length	Avi 10 Second	1-60 seconds
PIR Sensitivity	Normal	High, Low
PIR Interval	1 Minute	0-59 seconds, 1-60 minutes
Timer Interval	OFF	10 seconds to 8 hours
Timer Switch	Off	On (00:00 – 23:59)
Flash Range	15m	8m
Time Stamp	On	Off

Table 1: Default settings of the Camera

4.3 Firmware upgrade

This camera is provides an upgrading function for the users. Upgrading is needed only when an improved firmware is available.



5 Mounting the Camera

When you want to use the ON mode of the camera outside, such as hunting and monitoring the living habits of wild animals, you must mount the device on a certain place properly. To get the optimal picture quality, the tree can be 15 feet away from the place to be monitored, and at a height of 3-6 feet.

There are two ways to mount the camera: using a band shaped belt or the bottom screw.

- **Using the belt:** To use the belt to fix the camera on a tree is illustrated below. Adjust the belt to go through the two back holes of the camera. At the end, tie it off to secure the camera properly.
- **Using bottom screw.**



Figure 4: Fixing the camera with belt

Appendix I : Technical Specifications

Image Sensor	5MP Color CMOS
Lens	F/NO=3.1mm FOV(Field of View)=52°
IR-Flash	12-15m
Display Screen	2.0" TFT
Memory Card	From 8 MB to 8 GB
Picture Resolution	5MP = 2560×1920 3MP = 2048×1536
Video Resolution	640×480 (16fps) 320×240 (20fps)
PIR Sensor	Multi Zone
PIR Sensitivity	Adjustable (High/Normal/Low)
Trigger Time	1.2s
Weight *	0.24 kg
Operation/Storage Tem.	-20 - +60°C / -30 - +70°C
Interval	1s – 60 min.
Photo Burst	1–3
Video Length	1–60s
Power S"▲" ply	8× AA (recommend),4× AA(urgent)
Stand-by Current	< 0.3 mA (<7mAh/Day)
Power Consumption	150 mA(+450mA when IR-LED lighted)
Low Battery Alert	LED Indicator
Display Screen	LCD display
Mounting	Rope/Belt/Python lock
Dimensions**	140x 80x 50 mm
Operation Humidity	5% - 90%
Security authentication	FCC, CE, RoHS

*without battery

Appendix II : Parts List

Part Name	Quantity
Digital Camera	One
Wired control	One
USB Cable	One
Belt	One
User Manual	One