

SURE-LOC LETHAL WEAPON RED

WITH RETINA LOCK INSTRUCTIONS

Instructions also available at www.sureloc.com

Included with your Lethal Weapon:

- A. Lethal Weapon Bow Sight (1)
- B. Sure-Loc Hardware Kit (1)
 1. Hex Key Set
 2. 10-24 x 3/4" Flat Head Cap Screws (2)
 3. Sight Light

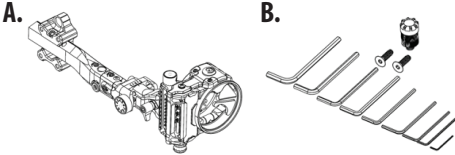

Setting up your Lethal Weapon

1. Attach the Lethal Weapon mounting block to the riser of your bow, using the supplied 10-24 x 3/4" Flat Head Cap Screws.
2. Slide the Lethal Weapon Bow Sight into the dovetail of the mounting block, and tighten down the mounting screw into one of the four indents on the sight.
- 3.



SIGHT IN YOUR TOP PIN AT PREFERRED DISTANCE!
DO NOT ADJUST ANY OF THE RETINA LOCK MICRO ADJUSTMENTS!!!!

We recommend sighting in at 20 yards using the windage, elevation, and pin adjustments.

**Once your top pin is accurately sighted in –
 It's time to adjust your Retina Lock™**

1. Draw your bow and look for the green Retina Lock™.
 - a) If you see the green Retina Lock™, adjust the green Retina Lock until the black dot is centered using the micro adjustments. The micro adjustment on the top of the sight is to move the green Retina Lock™ up and down and the adjustment on the side of the sight is to move the green Retina Lock™ left and right. Remember you are moving the green Retina Lock™ TO FIT YOUR FORM/ANCHOR POINT.

Example of adjustment: if the green Retina Lock™ is high and to the right, you will need to move the adjustment low and to the left. Repeat this step until the black dot is centered in the green dot

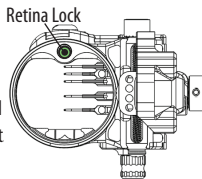

- b) If you don't see the green Retina Lock™ at full draw, move your anchor point/hand slightly until you find the green Retina Lock™.

Once you've determined the direction you need to move the green Retina Lock™ use a 1/16" hex key to adjust the micro adjustments to adjust accordingly. Once the black dot is centered in the green Retina Lock™ AT YOUR FORM/ANCHOR POINT it's time to sight in the rest of your pins!

Below shows the direction to adjust based on the location of the dots. To move Green Retina DOWN screw clockwise, to move UP screw counter clockwise. To move Green Retina IN toward the bow screw clockwise, to move OUT from bow screw counter clockwise.

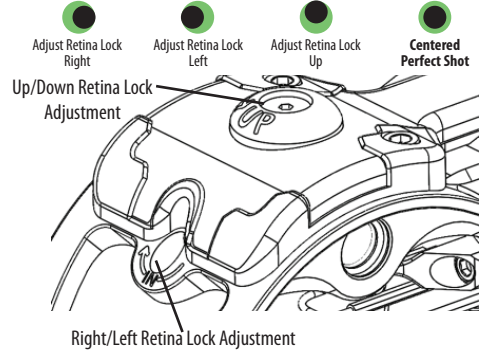

Lethal Weapon Features

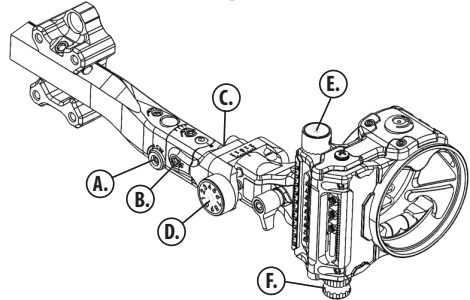

Gravity Drop Adjustment (A)

The Gravity Drop Adjustment allows the user to adjust the angle of the elevation frame relative to the riser of the bow. To adjust this angle, loosen the rear-most locking screw, and loosen/tighten the Gravity Drop adjustment screws located on either side of the extension bar. By loosening one side and tightening another, you will be able to achieve a maximum angle of 15 degrees in either direction. Once satisfied with the angle of the Gravity Drop adjustment, make sure that both adjustment screws are tight and finish by tightening the locking screw at the top of the extension.

3rd Axis Adjustment (B)

The Lethal Weapon's 3rd axis adjustment system works similarly to the Gravity Drop adjustment system. By loosening the top locking screw, and loosening/tightening the 3rd axis adjustment screw, the user will be able to achieve a maximum angle of 5 degrees in either direction. Once satisfied with the angle of the 3rd axis adjustment, make sure both adjustment screws are tight and finish by tightening the locking screw at the top of the extension.

Reversible Windage Offset (C)

The Windage offset of the Lethal Weapon is reversible to accommodate users who need to move their sight to extreme-right or extreme-left positions. To reverse the offset, loosen the 3rd axis adjustment and locking knobs, and remove the 3rd Axis Hinge Screw. Remove the offset bracket, and flip the offset bracket to the opposite orientation. Insert the offset bracket back into the extension, and replace the 3rd Axis Hinge Screw, making sure to tighten the screw all the way to the bottom.

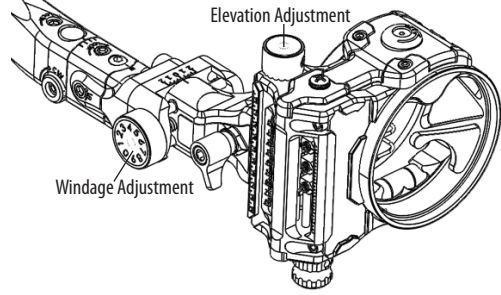

Windage Adjustment (D)

The Windage Adjustment of the Lethal Weapon allows the user to micro-adjust a total of .5" horizontally. Each click of the Windage adjustment knob moves the sight horizontally .002". The Windage adjustment does not have or need a locking mechanism, as it stays in the same position unless moved by the user.

Elevation Adjustment and Lock (E)

The Elevation Adjustment of the Icon allows the user to micro-adjust the scope of the sight vertically. To adjust the elevation of your Lethal Weapon, simply turn the locking knob counter clockwise to unlock the elevation adjustment, make the necessary adjustments, and finish by turning the locking knob clockwise to lock the adjustment. Each click of the Elevation adjustment knob moves the sight vertically .002".

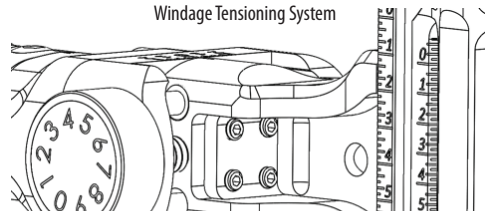

Windage Tensioning System

Uses four screws to increase/decrease the amount of tension felt in the Windage Adjustment. To adjust the tension of the Windage adjustment, turn the elevation locking knob counter clockwise until the knob comes off of the sight. Once the knob is off, you will also be able to remove the cover to the windage tensioning system, exposing four screws. Adjust these screws as necessary, then replace the cover and locking knob.

Micro Pin Adjustment (F)

Each pin can be individually micro-adjusted, or multiple pins can be adjusted at once. To adjust any pin, simply unscrew the set screw in each pin no less than 2 full turns using a 1/16" allen wrench. Once the set screw is loosened, the micro-adjust mode of each screw is engaged. To move a pin upwards, rotate the pin adjustment knob, located at the bottom of the sight, counter clockwise. Move the pin adjustment knob clockwise to move a pin down. Each click of the knob will move the pin exactly .0015". Once the pin is in the correct location, tighten the set screw of the pin to lock it in place.

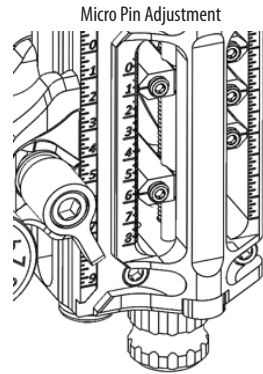

Care & Maintenance for your SURE-LOC Sight

Your SURE-LOC sight requires very little maintenance to keep adjustments crisp and firm. Use a spray contact cleaner to remove any dirty build up. If your sight gets wet, simply use a blow-dryer to dry it off. A **small drop of lightweight oil** may be used under the adjustment knobs on the ball bearing to reduce wear. But remember, oil attracts dirt so use it sparingly and keep your sight clean. **DO NOT use oil on any other moving parts of the sight.** We use special taps to resist bolt loosening and we recommend that you **DO NOT use Loctite** on any sight parts.